



SAFE DISTRIBUTION TECHNOLOGY
FOR PHOTOVOLTAIC SYSTEMS

[hensel.in](https://www.hensel.in)

HE^NSEL

ENYSUN – SOLUTIONS FOR PHOTOVOLTAICS

ENYSUN channels the power of the sun for your photovoltaic systems. Professional and smart thanks to pre-assembly. Safe due to the highest material quality. Standard-compliant thanks to HENSEL know-how.



HENSEL

4 ___ 5 Strong brand – Product overview

SAFE DISTRIBUTION TECHNOLOGY FOR PHOTOVOLTAIC SYSTEMS

6 ___ 13 Photovoltaic solutions
 14 ___ 15 Standard requirements
 16 ___ 17 System description
 18 ___ 43 PV connection boxes
 44 ___ 61 PV inverter collector

ACCESSORIES AND TECHNICAL APPENDIX

62 ___ 72 Accessories
 73 ___ 81 Technical information
 82 PV connection boxes checklist
 83 PV inverter collector checklist
 84 ___ 89 Service

Further technical information
 can be found on the Internet at
hensel.in > Products

MORE THAN 90 YEARS OF EXPERIENCE – YOUR ELECTRICAL ENERGY POWERS US

Electrical energy flows everywhere. It provides light, heat and movement. As a family-owned company operating worldwide, we guarantee the safe distribution of electrical energy in industry, commerce and infrastructure.

With over 1,000 employees, 640 of them in Germany, 14 subsidiaries in Germany and abroad, we have been operating successfully in the market for over 90 years. We work enthusiastically to take our products and services to the next level. Solutions for photovoltaics and e-mobility are becoming increasingly important. In this way, we are making an active contribution to the energy transition and working towards a safer electric future.

**Please scan the QR code or see our website
www.hensel.in
for more detailed information.**



FAMILY
COMPANY



SINCE
1931

International presence

HENSEL guarantees local support and a high degree of availability thanks to its 4 locations in Germany, 10 locations own by HENSEL and 60 international partners.

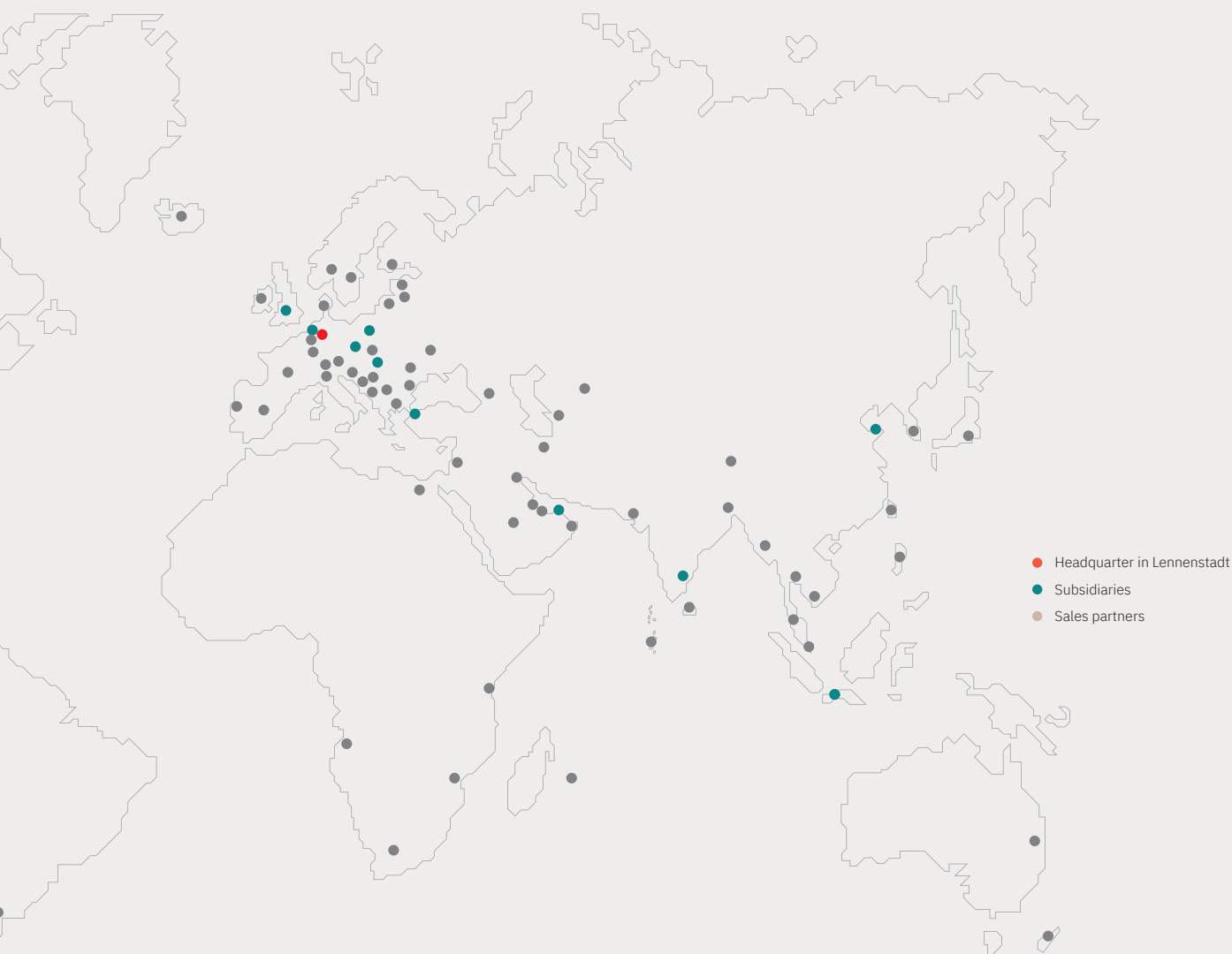

MORE THAN 60 INTERNATIONAL PARTNERS



ELECTRICAL INSTALLATION AND DISTRIBUTION SYSTEMS



1000 EMPLOYEES



13 SUBSIDIARIES NATIONALLY AND INTERNATIONALLY

PHOTOVOLTAIC SOLUTIONS FROM HENSEL

Product solutions with many advantages

INDIVIDUAL SOLUTIONS?
TALK TO US!





Standardised and pre-assembled

Our ENYSUN product solutions offer you many advantages when it comes to selecting and installing photovoltaic systems.

The PV connection boxes just need to be finally connected on site. Some of them have suitable plugs for easy contacting of the PV strings and inverters.

The PV inverter collectors are ready-to-connect distribution boards that are dimensioned to meet the special requirements of PV generation systems. The PV inverter collectors can be extended with products from the Mi range, e.g. over-voltage protection or boxes for ripple control receivers.

The mains connection can be made using isolation points (coupling switch + mains connection protection) in accordance with VDE AR-N 4105.

Proven HENSEL quality

The requirements of DIN VDE 0100-712 are implemented in all products of our ENYSUN distribution system.

The consistent compliance with this standard stands for the high quality level of the HENSEL + ENYSUN product range. By using high-quality materials, you can always rely on flawless functioning. ENYSUN systems are impact-resistant, dust-proof and waterproof (Degree of protection up to IP 65), UV-resistant and corrosion-resistant.

Accessories

In the accessories, you will find suitable products to effectively reduce the accumulation of condensation in the boxes.

PV CONNECTION BOXES

Protective devices for all applications





Completely assembled and wired ready for connection



With surge arresters, string fuses or generator isolators as required



Accessories for protected outdoor installation (e.g. canopy, pressure equalisation element)

INDIVIDUAL SOLUTIONS?
TALK TO US!



PV INVERTER COLLECTOR

Ready-to-connect solutions
for fast connection of the inverters

INDIVIDUAL SOLUTIONS?
TALK TO US!

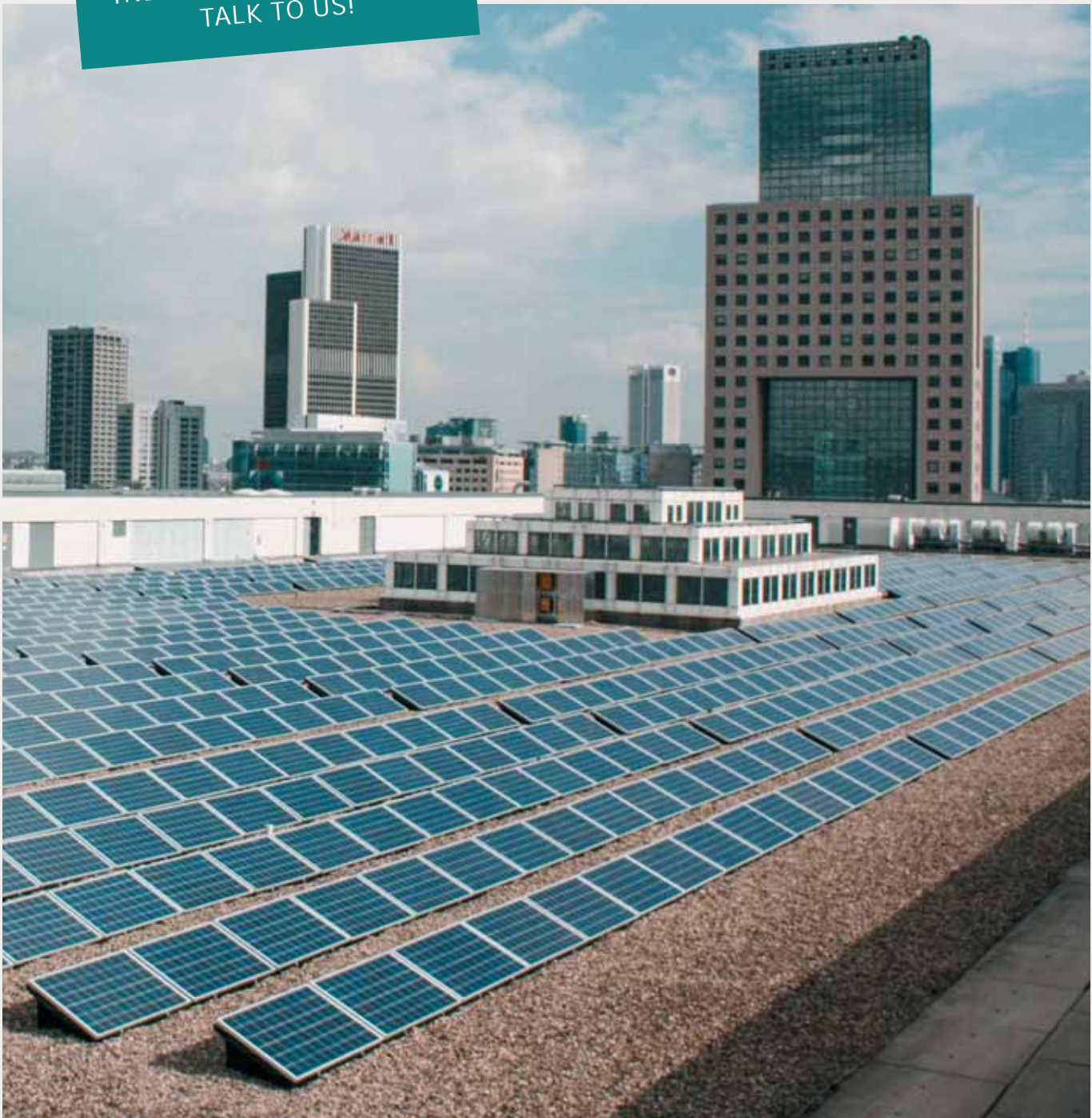



Ready-to-connect delivery of the PV inverter collectors, fully assembled and tested. No self-assembly of the distribution board is required; the installers can install it directly on the construction site. Consideration of the thermal effects of generation systems on distribution by specifying the total power of the PV inverter collector and the maximum connectable inverter power.

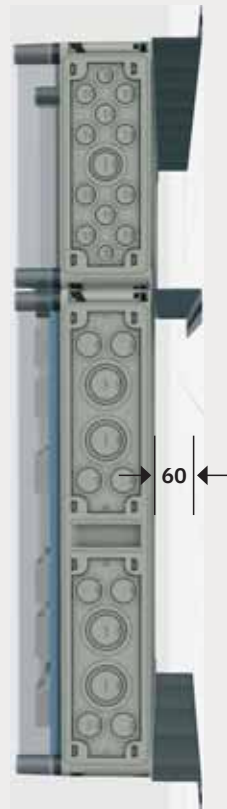

All PV inverter collectors are fitted on mounting profiles. This allows easy installation, even on uneven walls. Cables up to 60 mm in diameter can be laid behind the distribution board.



For the connection of Cu and Al conductors, all connections from size HRC 1 onwards are equipped with terminals for direct connection; with HRC 3, parallel cables are possible.

ENYSUN – SAFE DISTRIBUTION TECHNOLOGY FOR PHOTOVOLTAIC SYSTEMS

INDIVIDUAL SOLUTIONS?
TALK TO US!



- + PV connection boxes for PV systems up to 1500 V DC
- + PV inverter collector for a rated power of 350 kVA
- + Ready-to-connect isolation points for a rated power of 350 kVA
- + Degree of protection up to IP 65, Degree of protection II, double insulated



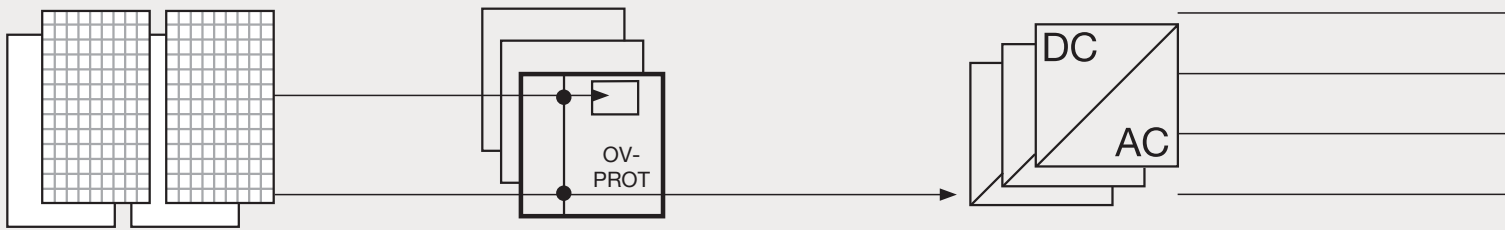

Certain standards and regulations must be observed when installing photovoltaic systems.

Excerpts from standard requirements are listed below.

DIN VDE 0100-712: 2016-10
Low-voltage electrical installations
Part 7-712: Requirements for special installations or locations – Photovoltaic (PV) systems

PV connection boxes

712.412.101 The electrical equipment of the PV generator field **must** meet the requirements of **protection class II**.

712.514.102 Each access point to active parts on the DC side, such as distribution boards and junction boxes, shall have a permanent marking indicating that active parts may still be energised after disconnection, for example by the text:

“PV DC voltage - active parts may be live after disconnecting!”

712.511.103 junction boxes or distributors and switchgear combinations

Connection boxes, distributors and switchgear combinations must comply with the IEC 61439 series of standards (VDE 0660-600).

IEC 61439-1 (VDE 0660-600-1)

Low-voltage switchgear and controlgear assemblies

Part 1: General rules

10.9.4 For switchgear combinations with insulating material sheaths, an additional insulation test shall be carried out, ...

For this additional test, a test voltage must be 1.5 times the voltage specified in Table 8.



PV inverter collector

712.433.104 Protection of power cables/lines on the AC side

The maximum output current of the inverter must be taken into account when specifying the rated current of the overcurrent protection device of the PV supply cables/lines on the AC voltage side.

The maximum output current of the inverter is either the maximum AC current specified by the manufacturer of the inverter or, if no manufacturer's information is available, 1.1 times the rated AC current of the inverter.

712.434 Protection for short-circuit currents

712.434.101 The PV supply cable/line on the AC side shall be protected by a protective device for short-circuit protection or by an overcurrent protection device installed at the connection point on the AC side.

Isolation point

VDE-AR-N 4105:2018-11

Generators connected to the low-voltage distribution network Technical requirements for the connection to and parallel operation with low-voltage distribution networks

The application guide has come into force in conjunction with VDE-AR-N 4100. Since 27/04/2019, all generation systems < 135 kW have to be built and operated according to this application guide.

Systems ≥ 135 kW are built and operated in accordance with VDE-AR-N 4110, regardless of the connection point to the grid operator.

DEPENDENT ON THE SYSTEM

Electrical ratings



Rated current: up to 630 A
Rated insulation voltage: 690 V AC, **1000 V DC**, VDE 0110
**The rated values may be reduced by the built-in device technology;
see the information on the product or the Technology tab**

**Electrical
Rated values**

System properties



**Ambient
Conditions**

Ambient temperature
+ for distribution boards in accordance with IEC 61439:
-5 °C up to 35 °C, max. + 40 °C,
Relative humidity: 50% at 40 °C,
100% at 25 °C
+ for empty enclosures:
- 25 °C up to + 70 °C
The climatic influences and effects on the equipment are to be considered, see technical details /operating and ambient conditions



Impact strength

Mechanical impact protection
IK 08 (5 Joules) according to IEC 50102



**Application
area**

The enclosures are suitable for protected outdoor installation.
However, the climatic influences and effects on the operating equipment must be taken into account.



**Protection against
foreign solid objects
and direct contact**

Dust-proof
Degree of protection IP **65**



Insulation

Insulated enclosures
(Protection Class II)



**Protection against
ingress of water
with harmful effects**

Protected against water jets
Degree of protection IP **65**

DEPENDENT ON MATERIAL

Material properties: Polycarbonate



Burning behaviour

Glow wire test 960 °C in accordance with IEC 60695-2-11 self-extinguishing, flame retardant



Chemical resistance

Resistance against acids 10% and alkaline 10%, petrol and mineral oil



UV resistance

UV-resistant in accordance with IEC 61439-1, para. 10.2.4: The material is tested for UV resistance.



Toxic behaviour

Silicone- and halogen-free

ENYSUN PV CONNECTION BOXES



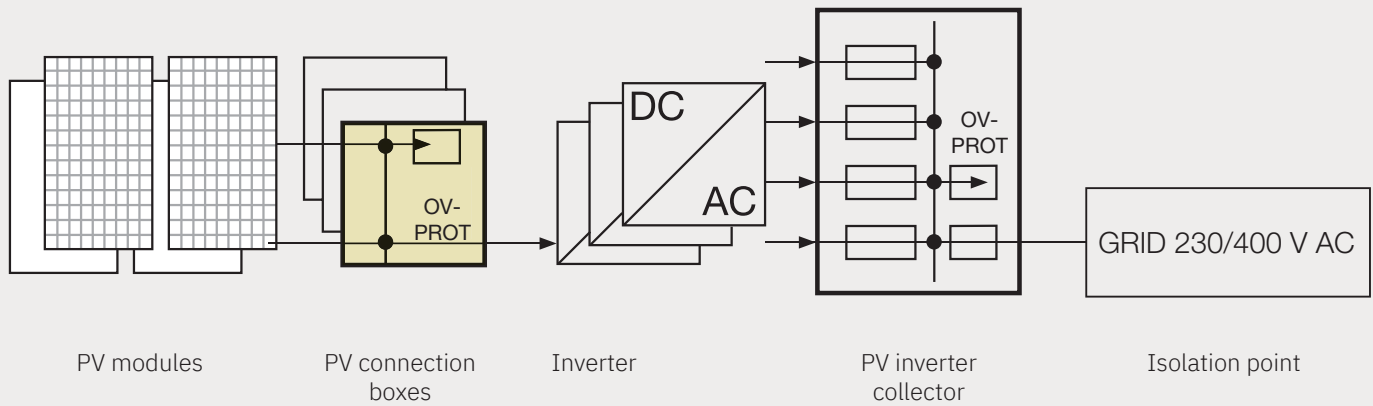

System properties

+ Connection:

Ready to connect with connectors or included cable entries

+ Electrical data:

Rated voltage: 1500 V DC
 Rated current: up to 240 A
 Protective measure: Protective insulation

+ Environmental conditions:

UV-resistant
 Degree of protection: IP 65
 Optional: Suitable products to effectively reduce the accumulation of condensation in the boxes (e.g. combi-ventilation glands, canopy, ventilation flange)

More information about these products:
hensel-electric.in



The individual boxes are suitable for outdoor use.

The box materials used for the Mi system are generally UV-resistant, so that the mechanical strength of the encapsulation is maintained when exposed to UV.

Due to the direct sunlight and the heat loss generated in the box, the interior of the box may become overheated. Lower outside temperatures, e.g. below -5 °C, also affect the equipment technology. Therefore, the climatic effects and effects on the equipment technology must be taken into account.

The top of the boxes should be protected by a cover, e.g. a canopy, against these weather-related influences, such as rain, ice and snow.

When selecting the installation location, in addition to the IP degree of protection and climatic influences, adverse effects due to chemical influences should perhaps be considered.

Additional measures, such as ventilation, may be necessary to comply with the maximum permissible ambient temperature of the built-in devices and to prevent condensation (considering the degree of protection). In an outdoor application, Hensel combi-ventilation glands (KBM) can be used, for example, for cable entry and pressure compensation (see accessories).

How does condensed water form in boxes with a high degree of protection?

The problem of condensation water formation only occurs in boxes with a high degree of protection \geq IP 54, because the high impermeability of the boxes and their materials causes too little air compensation from the inside to the outside.

System switched on.

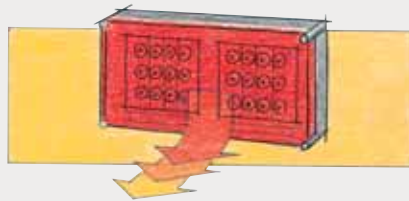

The internal temperature is higher than the ambient temperature due to the power loss of the built-in devices.

System switched on.

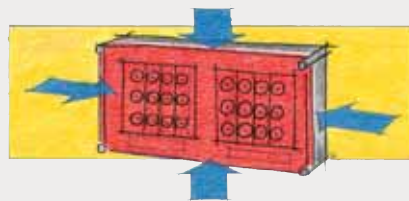

The warm indoor air tries to accumulate moisture. This comes from the outside through the sealing area because boxes are not gas-tight.

System switched off

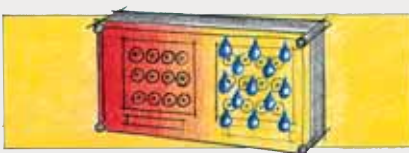

By cooling the system, e.g. by switching off the loads, the internal temperature decreases. The cooler air releases moisture, which settles as condensation water on the cooler inner surfaces of the box.

Formation of condensation in installations in rooms:

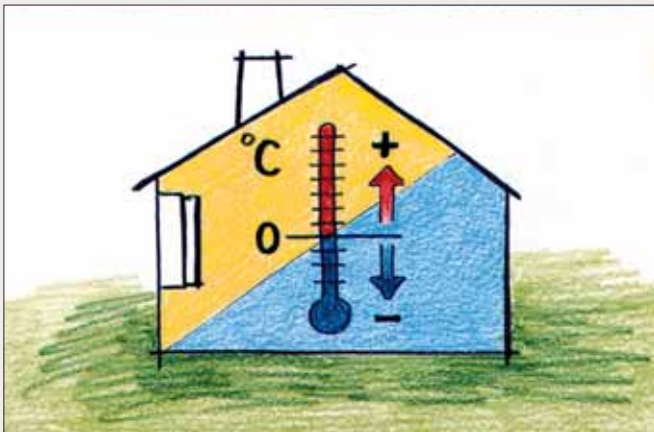

Wherever high humidity and large temperature changes are to be expected, e.g. in laundries, kitchen facilities, car washes etc.

Formation of condensation in protected or unprotected outdoor installations:

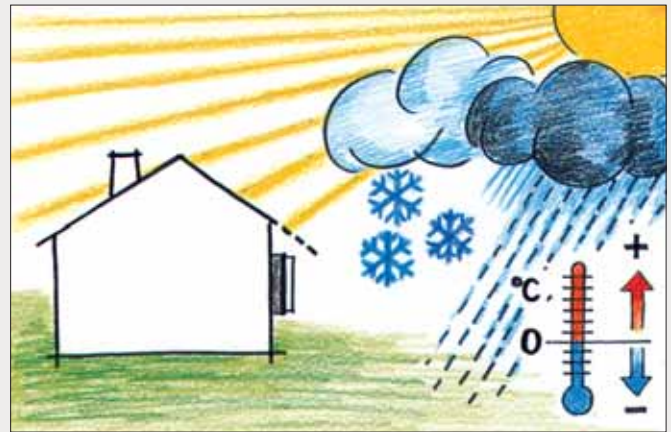

Condensed water can form here depending on the weather, high humidity, direct sunlight and temperature gradient to the wall.



Environmental conditions:

Degree of protection: IP 65
stainless steel external brackets,
optional: Suitable products to effectively reduce the accumulation of condensation in the box (e.g. pressure compensation elements, canopy, ventilation flange)

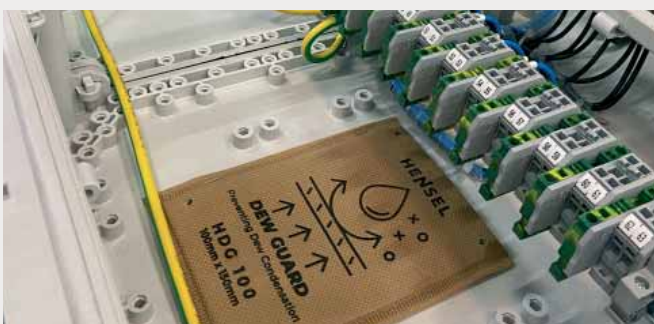

Absorbs moisture without any saturation, even in high humidity, provided the right sizes are used. Absorbency of 0.8g (H₂O) / 1g (product) @25 deg C / IP65 and 95% relative humidity or higher. Can be used for a long period of time thanks to its humidity absorption / release function. In case insufficient numbers are used and the Dew Guard is wet and saturated, it can be dried in sunlight and put back in use.



Due to the exposed arrangement of photovoltaic generators on roofs or in the open area, lightning and surge protection is an important part of investment protection.

Direct lightning strikes into the PV generator can, for example, destroy the PV modules and inverters (primary damage).

Since photovoltaic (PV) systems inevitably have a connection to the electrical installation of the building, damage to the entire system can occur in the event of lightning in the PV generator (secondary effect).

Many indemnity insurers therefore refer to the VdS data sheet 2010: “Risk-orientated lightning and surge protection, guidelines for loss prevention”, which recommends external lightning protection for PV systems over 10 kWp.

Protective measures

In principle, it should be ensured that no direct lightning strikes into the PV generator are possible. There are suitable products for this purpose to implement external lightning protection.

If an external lightning protection system is available, a type 1 lightning current arrester must be provided in the main building distribution board for the AC supply.

Protection of inverters

In order to protect the inverters against surges, both the DC inputs and AC outputs must be protected. If the inverter is installed at a distance of $l > 10$ m cable length from the main building distribution board, a type 2 surge protection device (SPD) must be used for the AC line to prevent surge damage, e.g. due to switching surges from the supply network.

Special type 2 surge protection devices suitable for DC voltage must be provided for the string lines of the DC inputs. The decisive factor is the individual lightning and surge protection concept.

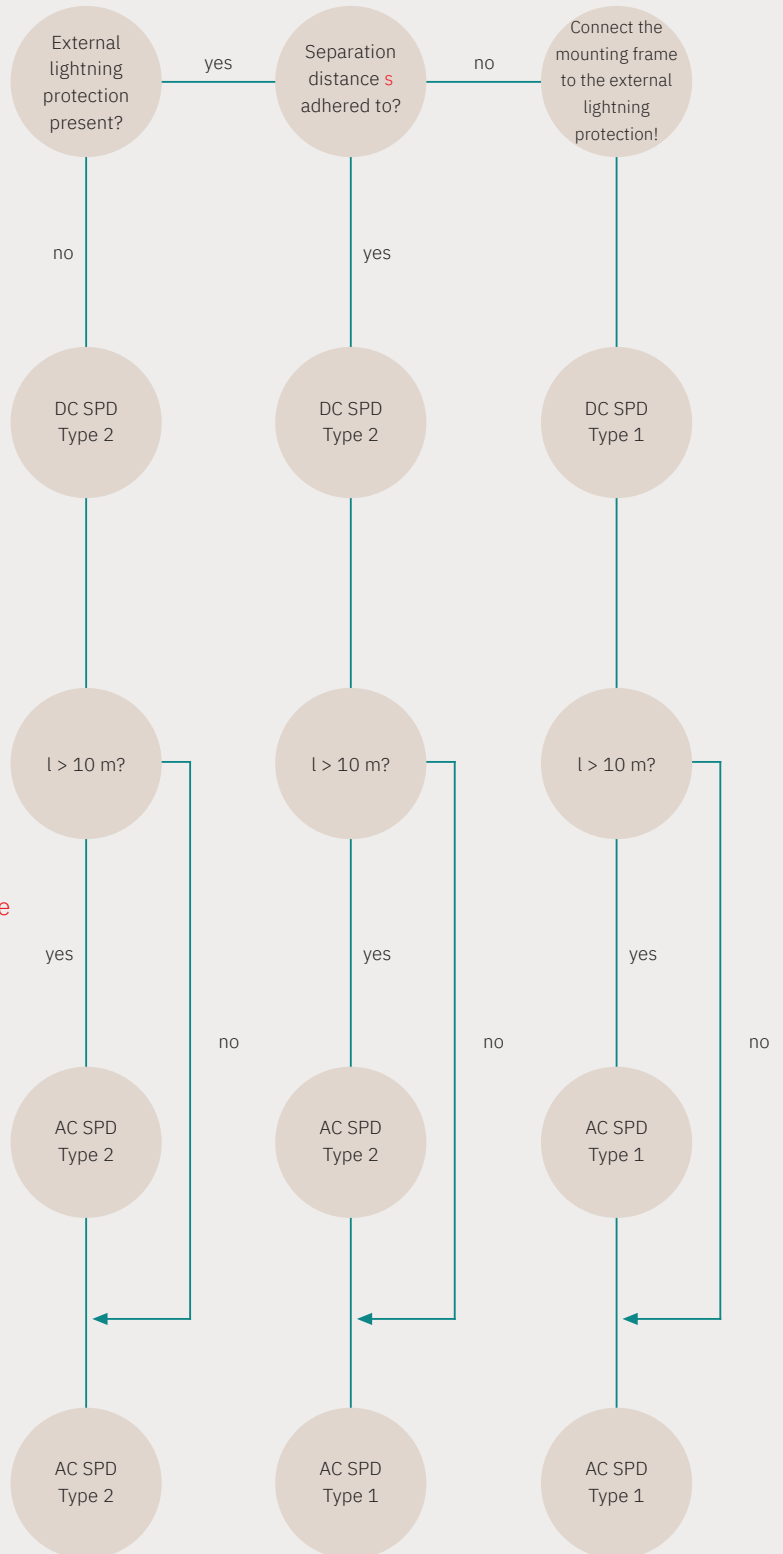
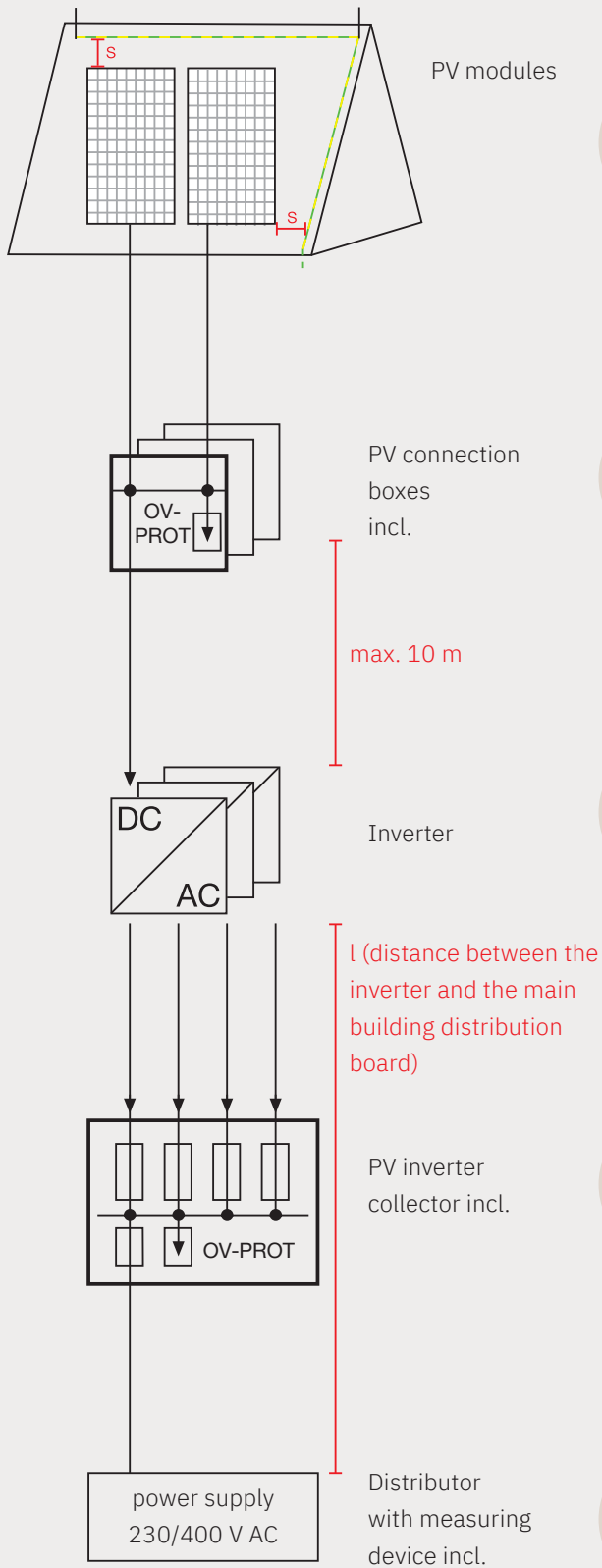

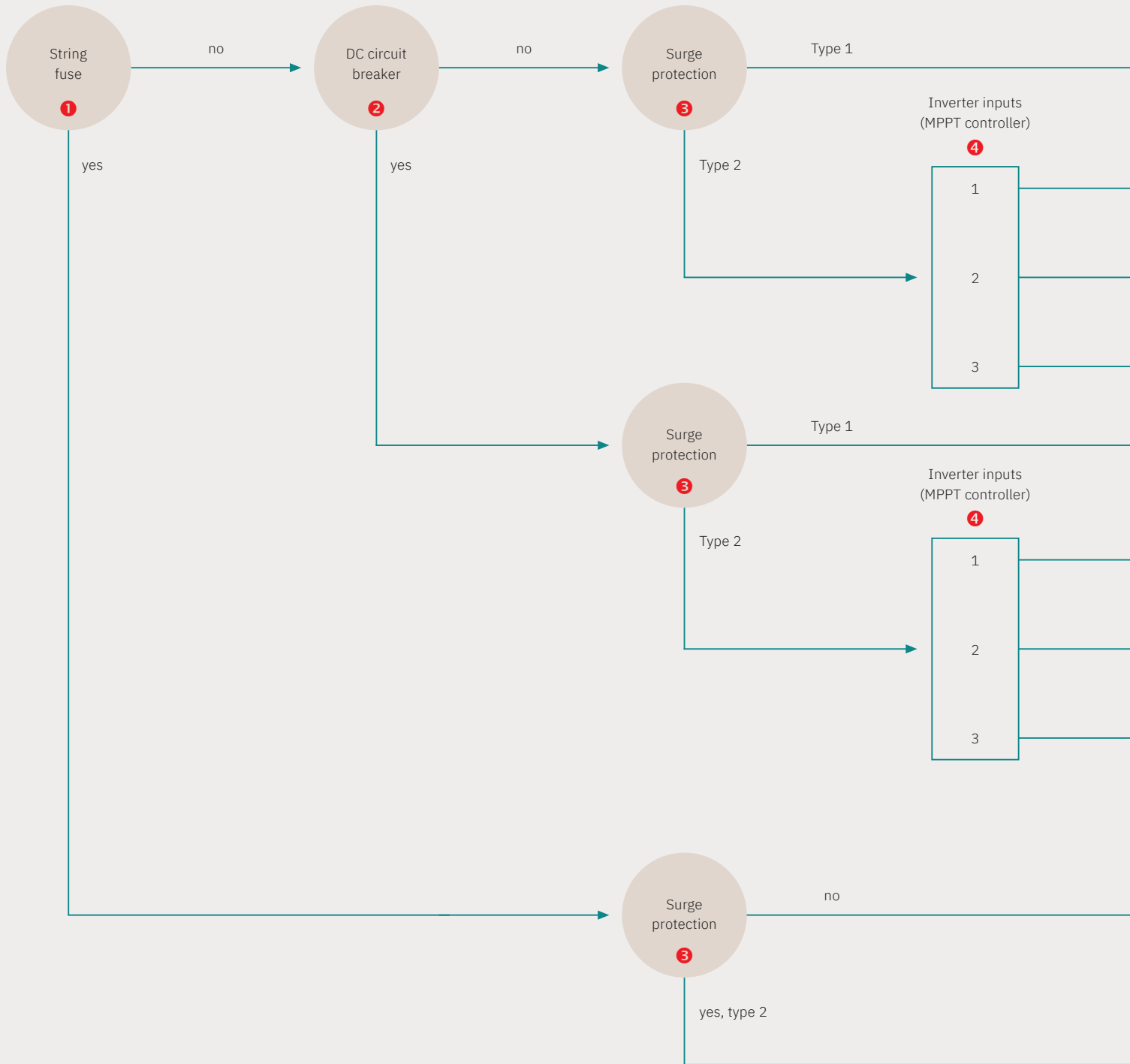

1
 Check whether a surge protection device is necessary. See the requirements in DIN VDE 0100-712

712.430 Overcurrent protection

712.431 Requirements according to the type of circuits

712.431.101 In a PV generator field with parallel PV strings of the number of LV (with LV > 2), protective devices must be provided to protect each PV string if the following condition is met: $1.35 \text{ IMOD_MAX O CPR} < (\text{NS} - 1) \text{ ISC MAX}$ An overcurrent protection device is not required for a number of LV ≤ 2 .

2
 Check whether a generator disconnect switch must also be used. This can already be integrated into the inverter! See the requirements in DIN VDE 0100-712

712.537 Disconnecting and switching

712.537.2 Disconnecting

712.537.2.101 For the repair and maintenance of the inverter, devices must be provided to separate the inverter from the DC and AC sides.

712.537.2.2 Devices for disconnecting

712.537.2.2.101 DC side disconnection device

A switch disconnecter or a circuit-breaker suitable for disconnecting must be provided on the DC side of the inverter.

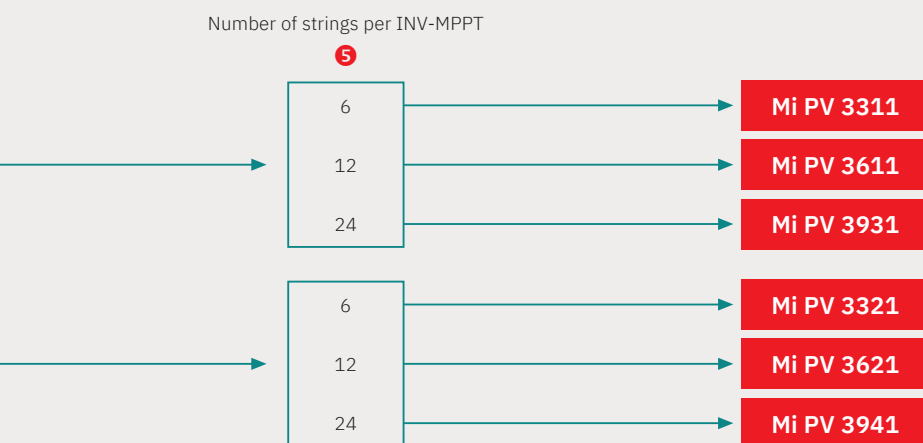
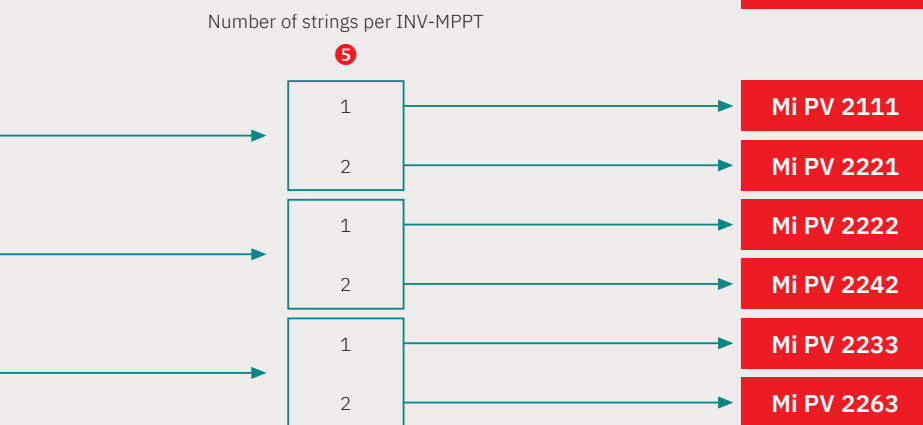
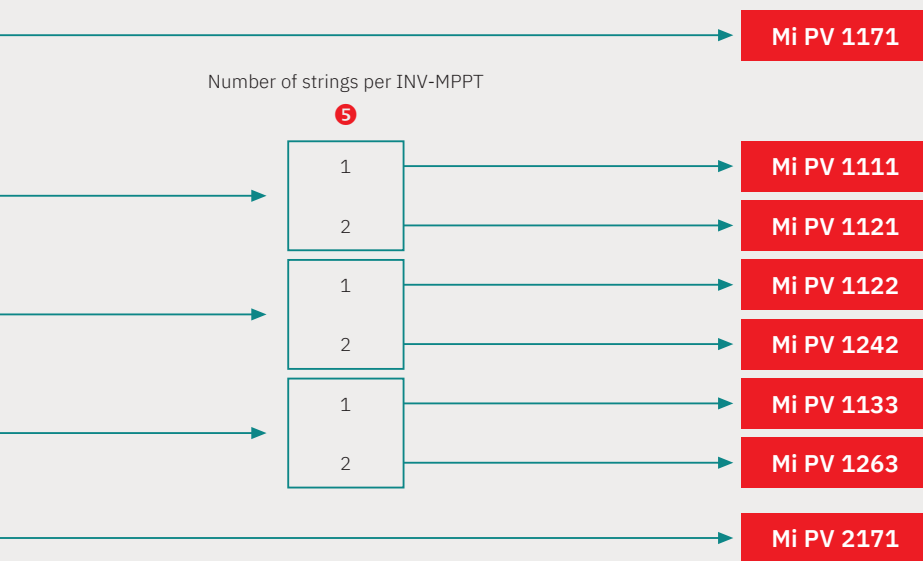

4
How many independent MPPT controllers does the inverter have?

Many inverters have several independent MPPT controllers. This enables differently equipped or aligned PV strings to be connected to an inverter.

If there are more MPPT controllers than are possible in one PV terminal box, additional PV terminal boxes can be selected.

5
How many strings will be connected to one independent MPPT controller?

In order to increase the PV power for the MPPT controller, PV strings can be connected in parallel. The parallel connection in the PV connection boxes can be carried out without or with string fuses.

3
Check whether a surge protection device (SPD) is necessary.

712.534 Devices for surge protection

The selection and installation of surge protection devices (SPDs) in PV systems must be carried out in accordance with IEC 62305-3 Supplement 5 (VDE 0185-305-3 Supplement 5).

712.443.101 Transient surge protection

If transient surge protection is required by DIN VDE 0100-443 (VDE 0100-443), Section 443, such protection must also be applied on the DC side of the PV system.

Depending on the distance between the inverter and the power supply point of the electrical system, further transient surge protection on the AC side may be required.



KV PV 1211

1 x PV string to 1 x inverter input
1 x type 2 DC surge arrester

- + ready for connection
- + Type 2 DC surge arrester
Limit leakage surge current DC (8/20) I_{total} : 40 kA
DC protection level: < 4 kV
- + Plug-in connectors compatible with MC4
Length of connection cables: 2 x 500 mm
- + Rated connecting capacity PE: 1.5-16 mm², Cu
- + with mounting plate for wall and pole mounting
made of stainless steel

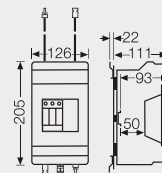

| | |
|---|----------------------------------|
| Rated voltage | $U_{OC,STC} = 1000 \text{ V DC}$ |
| Rated current of the switchgear combination | $I_{nA} = 30 \text{ A}$ |
| Rated current of a circuit | $I_{nC} = 30 \text{ A}$ |
| RDF (Rated Diversity Factor) | 1 |



KV PV 2211

1 x PV string to 1 x inverter input
1 x DC generator circuit breaker

- + ready for connection
- + DC generator circuit breaker
Utilisation category for switch disconnector:
DC 21A = switching resistive load including moderate overload
- + Plug-in connectors compatible with MC4
Length of connection cables: 2 x 500 mm
- + with mounting plate for wall and pole mounting
made of stainless steel

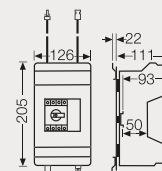

| | |
|---|----------------------------------|
| Rated voltage | $U_{OC,STC} = 1000 \text{ V DC}$ |
| Rated current of the switchgear combination | $I_{nA} = 30 \text{ A}$ |
| Rated current of a circuit | $I_{nC} = 30 \text{ A}$ |
| RDF (Rated Diversity Factor) | 1 |



Installation of PV connection boxes KV PV ... Possible in default wall and pole mounting.

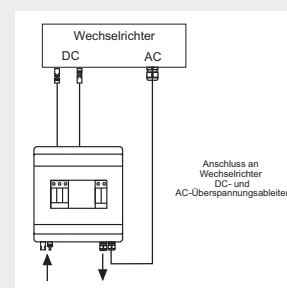



KV PV 2411

- 1 x PV string to 1 x inverter input
- 1 x type 2 DC surge arrester
- 1 x DC generator circuit breaker

- + ready for connection
- + Type 2 DC surge arrester
Limit leakage surge current DC (8/20) I_{total} : 40 kA
DC protection level: < 4 kV
- + DC generator circuit breakers
Utilisation category for switch disconnecter: DC 21A = switching resistive load including moderate overload
- + Plug-in connectors compatible with MC4
Length of connection cables: 2 x 500 mm
- + Rated connecting capacity PE: 1.5-16 mm², Cu
- + with mounting plate for wall and pole mounting made of stainless steel

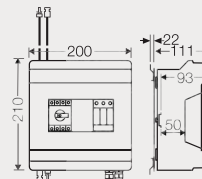

| | |
|---|-----------------------------------|
| Rated voltage | $U_{OC_STC} = 3000 \text{ V DC}$ |
| Rated current of the switchgear combination | $I_{nA} = 30 \text{ A}$ |
| Rated current of a circuit | $I_{nc} = 30 \text{ A}$ |
| RDF (Rated Diversity Factor) | 1 |



To protect from unauthorised access



Locking device
KV ES 3



Sealing device
KV PL 3



Mi PV 1111

1 x PV string to 1 x inverter input
1 x type 2 DC surge arrester

- + ready for connection
- + Type 2 DC surge arrester
Limit leakage surge current DC (8/20) I_{total} : 40 kA
DC protection level: < 4 kV
- + Plug-in connectors compatible with MC4
- + Rated connecting capacity PE: 1.5-16 mm², Cu
- + Lid fasteners for tool operation
- + with stainless steel mounting plate

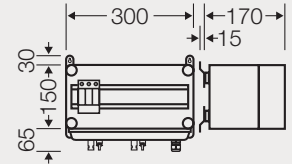

| | |
|---|-----------------------------|
| Rated voltage | $U_{OC\ STC} = 1000\ V\ DC$ |
| Rated current of the switchgear combination | $I_{nA} = 1 \times 30\ A$ |
| Rated current of a circuit | $I_{nc} = 30\ A$ |
| RDF (Rated Diversity Factor) | 1 |



Mi PV 1122

2 x PV strings to 2 x inverter inputs
2 x type 2 DC surge arresters

- + ready for connection
- + Type 2 DC surge arrester
Limit leakage surge current DC (8/20) I_{total} : 40 kA
DC protection level: < 4 kV
- + Plug-in connectors compatible with MC4
- + Rated connecting capacity PE: 1.5 - 16 mm², Cu
- + Lid fasteners for tool operation
- + with stainless steel external brackets

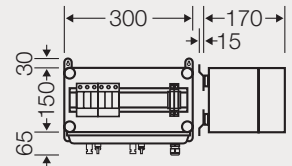

| | |
|---|-----------------------------|
| Rated voltage | $U_{OC\ STC} = 1000\ V\ DC$ |
| Rated current of the switchgear combination | $I_{nA} = 2 \times 30\ A$ |
| Rated current of a circuit | $I_{nc} = 30\ A$ |
| RDF (Rated Diversity Factor) | 1 |





Mi PV 1133

3 x PV strings to 3 x inverter inputs
3 x type 2 DC surge arresters

- + ready for connection
- + Type 2 DC surge arrester
Limit leakage surge current DC (8/20) I_{total} : 40 kA
DC protection level: < 4 kV
- + Plug-in connectors compatible with MC4
- + Rated connecting capacity PE: 1.5-16 mm², Cu
- + Lid fasteners for tool operation
- + with stainless steel external brackets

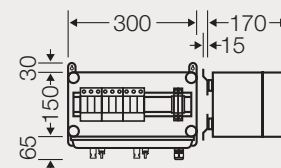

| | |
|---|-----------------------------|
| Rated voltage | $U_{OC\ STC} = 1000\ V\ DC$ |
| Rated current of the switchgear combination | $I_{nA} = 3 \times 30\ A$ |
| Rated current of a circuit | $I_{nc} = 30\ A$ |
| RDF (Rated Diversity Factor) | 1 |



Accessories to reduce condensed water



Dewguard



Pressure equalising element BM xxG



Canopy MI DB ...



Ventilation flange MI BF 44



Mi PV 1121

2 x PV strings to 1 x inverter input
1 x type 2 DC surge arrester

- + ready for connection
- + Type 2 DC surge arrester
Limit leakage surge current DC (8/20) I_{total} : 40 kA
DC protection level: < 4 kV
- + Plug-in connectors compatible with MC4
- + Rated connecting capacity PE: 1.5-16 mm², Cu
- + Lid fasteners for tool operation
- + with stainless steel external brackets

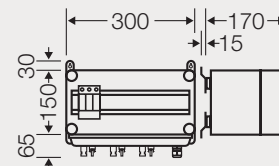

| | |
|---|-----------------------------|
| Rated voltage | $U_{OC\ STC} = 1000\ V\ DC$ |
| Rated current of the switchgear combination | $I_{nA} = 1 \times 30\ A$ |
| Rated current of a circuit | $I_{nc} = 15\ A$ |
| RDF (Rated Diversity Factor) | 1 |



Mi PV 1242

4 x PV string for 2 x inverter input
2 x type 2 DC surge arresters

- + ready for connection
- + Type 2 DC surge arrester
Limit leakage surge current DC (8/20) I_{total} : 40 kA
DC protection level: < 4 kV
- + Plug-in connectors compatible with MC4
- + Rated connecting capacity PE: 1.5 - 16 mm², Cu
- + Lid fasteners for tool operation
- + with stainless steel external brackets

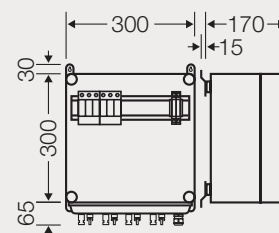

| | |
|---|-----------------------------|
| Rated voltage | $U_{OC\ STC} = 1000\ V\ DC$ |
| Rated current of the switchgear combination | $I_{nA} = 2 \times 30\ A$ |
| Rated current of a circuit | $I_{nc} = 15\ A$ |
| RDF (Rated Diversity Factor) | 1 |





Mi PV 1263

6 x PV string for 3 x inverter input
3 x type 2 DC surge arresters

- + ready for connection
- + Type 2 DC surge arrester
Limit leakage surge current DC (8/20) I_{total} : 40 kA
DC protection level: < 4 kV
- + Plug-in connectors compatible with MC4
- + Rated connecting capacity PE: 1.5-16 mm², Cu
- + Lid fasteners for tool operation
- + with stainless steel external brackets

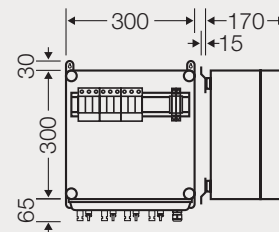

| | |
|---|-----------------------------|
| Rated voltage | $U_{OC\ STC} = 1000\ V\ DC$ |
| Rated current of the switchgear combination | $I_{nA} = 3 \times 30\ A$ |
| Rated current of a circuit | $I_{nc} = 15\ A$ |
| RDF (Rated Diversity Factor) | 1 |



Accessories to reduce condensed water



Dewguard
HDG



Pressure equalising
element BM xxG



Canopy
MI DB ...



Ventilation flange
MI BF 44



Mi PV 2111

1 x PV string to 1 x inverter input
 1 x type 2 DC surge arrester and
 1 x DC generator circuit breaker

- + ready for connection
- + Type 2 DC surge arrester
 Limit leakage surge current DC (8/20) I_{total} : 40 kA
 DC protection level: < 4 kV
- + DC generator circuit breaker
 usage category for switch disconnectors: DC 21A = switching resistive load including moderate overload
- + Plug-in connectors compatible with MC4
- + Rated connecting capacity PE: 1.5-16 mm², Cu
- + Lid fasteners for tool operation
- + with stainless steel external brackets

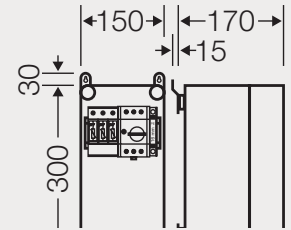

| | |
|---|-----------------------------|
| Rated voltage | $U_{OC\ STC} = 1000\ V\ DC$ |
| Rated current of the switchgear combination | $I_{nA} = 1 \times 30\ A$ |
| Rated current of a circuit | $I_{nc} = 30\ A$ |
| RDF (Rated Diversity Factor) | 1 |



Mi PV 2222

2 x PV strings to 2 x inverter inputs
 2 x type 2 DC surge arresters and
 2 x DC generator disconnect switch

- + ready for connection
- + Type 2 DC surge arrester
 Limit leakage surge current DC (8/20) I_{total} : 40 kA
 DC protection level: < 4 kV
- + DC generator circuit breaker
 usage category for switch disconnectors: DC 21A = switching resistive load including moderate overload
- + Plug-in connectors compatible with MC4
- + Rated connecting capacity PE: 1.5 - 16 mm², Cu
- + Lid fasteners for tool operation
- + with stainless steel external brackets

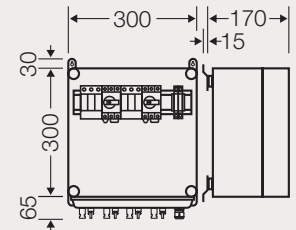

| | |
|---|-----------------------------|
| Rated voltage | $U_{OC\ STC} = 1000\ V\ DC$ |
| Rated current of the switchgear combination | $I_{nA} = 2 \times 30\ A$ |
| Rated current of a circuit | $I_{nc} = 30\ A$ |
| RDF (Rated Diversity Factor) | 1 |





Mi PV 2233

3 x PV strings to 3 x inverter inputs
 3 x type 2 DC surge arresters and
 3 x DC generator circuit breakers

- + ready for connection
- + Type 2 DC surge arrester
 Limit leakage surge current DC (8/20) I_{total} : 40 kA
 DC protection level: < 4 kV
- + DC generator circuit breaker
 usage category for switch disconnectors: DC 21A = switching
 resistive load including moderate overload
- + Plug-in connectors compatible with MC4
- + Rated connecting capacity PE: 1.5-16 mm², Cu
- + Lid fasteners for tool operation
- + with stainless steel external brackets

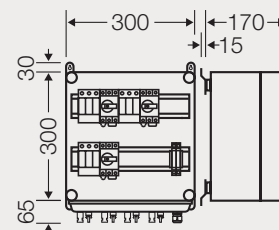

| | |
|---|-----------------------------|
| Rated voltage | $U_{OC\ STC} = 1000\ V\ DC$ |
| Rated current of the switchgear combination | $I_{nA} = 3 \times 30\ A$ |
| Rated current of a circuit | $I_{nc} = 30\ A$ |
| RDF (Rated Diversity Factor) | 1 |



To protect from unauthorised access



Sealing cap
 Mi PL 2



Lid fastener for
 tool operation
 Mi DR 04



Mi PV 2121

2 x PV strings to 1 x inverter input
 1 x type 2 DC surge arrester and
 1 x DC generator circuit breaker

- + ready for connection
- + Type 2 DC surge arrester
 Limit leakage surge current DC (8/20) I_{total} : 40 kA
 DC protection level: < 4 kV
- + DC generator circuit breaker
 usage category for switch disconnectors: DC 21A = switching resistive load including moderate overload
- + Plug-in connectors compatible with MC4
- + Rated connecting capacity PE: 1.5-16 mm², Cu
- + Lid fasteners for tool operation
- + with stainless steel external brackets

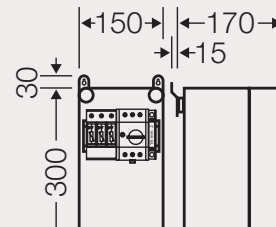

| | |
|---|-----------------------------|
| Rated voltage | $U_{OC\ STC} = 1000\ V\ DC$ |
| Rated current of the switchgear combination | $I_{nA} = 1 \times 30\ A$ |
| Rated current of a circuit | $I_{nc} = 15\ A$ |
| RDF (Rated Diversity Factor) | 1 |



Mi PV 2242

4 x PV string for 2 x inverter input
 2 x type 2 DC surge arresters and
 2 x DC generator disconnect switch

- + ready for connection
- + Type 2 DC surge arrester
 Limit leakage surge current DC (8/20) I_{total} : 40 kA
 DC protection level: < 4 kV
- + DC generator circuit breaker
 usage category for switch disconnectors: DC 21A = switching resistive load including moderate overload
- + Plug-in connectors compatible with MC4
- + Rated connecting capacity PE: 1.5 - 16 mm², Cu
- + Lid fasteners for tool operation
- + with stainless steel external brackets

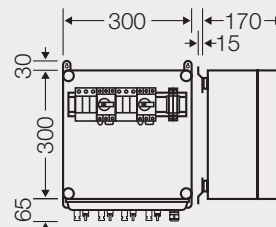

| | |
|---|-----------------------------|
| Rated voltage | $U_{OC\ STC} = 1000\ V\ DC$ |
| Rated current of the switchgear combination | $I_{nA} = 2 \times 30\ A$ |
| Rated current of a circuit | $I_{nc} = 15\ A$ |
| RDF (Rated Diversity Factor) | 1 |





Mi PV 2263

6 x PV string for 3 x inverter input
 3 x type 2 DC surge arresters and
 3 x DC generator circuit breakers

- + ready for connection
- + Type 2 DC surge arrester
 Limit leakage surge current DC (8/20) I_{total} : 40 kA
 DC protection level: < 4 kV
- + DC generator circuit breaker
 usage category for switch disconnectors: DC 21A = switching
 resistive load including moderate overload
- + Plug-in connectors compatible with MC4
- + Rated connecting capacity PE: 1.5-16 mm², Cu
- + Lid fasteners for tool operation
- + with stainless steel external brackets

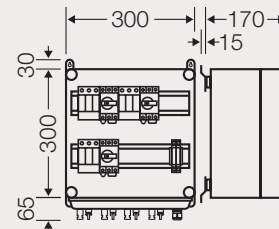

| | |
|---|-----------------------------|
| Rated voltage | $U_{OC\ STC} = 1000\ V\ DC$ |
| Rated current of the switchgear combination | $I_{nA} = 3 \times 30\ A$ |
| Rated current of a circuit | $I_{nc} = 15\ A$ |
| RDF (Rated Diversity Factor) | 1 |

To protect from unauthorised access



Sealing cap
 Mi PL 2



Lid fastener for
 tool operation
 Mi DR 04



Mi PV 1171

2 x PV strings to 1 x inverter input
1 x types 1 + 2 DC surge arrester

- + ready for connection
- + Types 1 + 2 DC surge arrester
Lightning surge current DC (10/350) [DC+/DC- -> PE] I_{imp} : 12.5 kA
Protection level [DC+/DC- -> PE]: < 3.8 kV
- + Plug-in connectors compatible with MC4
- + Rated connecting capacity PE: 1.5-25 mm², Cu
- + Lid fasteners for tool operation
- + with stainless steel external brackets

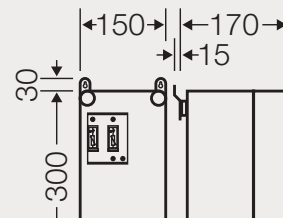

| | |
|---|-----------------------------|
| Rated voltage | $U_{OC\ STC} = 1000\ V\ DC$ |
| Rated current of the switchgear combination | $I_{nA} = 1 \times 30\ A$ |
| Rated current of a circuit | $I_{nc} = 15\ A$ |
| RDF (Rated Diversity Factor) | 1 |





Mi PV 2171

2 x PV strings to 1 x inverter input
 1 x types 1 + 2 DC surge arrester and
 1 x DC generator circuit breaker

- + ready for connection
- + Types 1 + 2 DC surge arrester
 Lightning surge current DC (10/350) [DC+/DC- -> PE] I_{imp} : 12.5 kA
 Protection level [DC+/DC- -> PE]: < 3.8 kV
- + DC generator circuit breaker
 usage category for switch disconnectors: DC 21A = switching
 resistive load including moderate overload
- + Plug-in connectors compatible with MC4
- + Rated connecting capacity PE: 1.5-25 mm², Cu
- + Lid fasteners for tool operation
- + with stainless steel external brackets

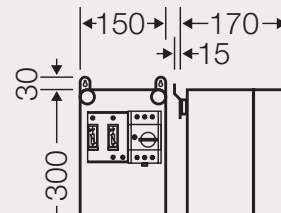

| | |
|---|-----------------------------|
| Rated voltage | $U_{OC\ STC} = 1000\ V\ DC$ |
| Rated current of the switchgear combination | $I_{NA} = 1 \times 30\ A$ |
| Rated current of a circuit | $I_{nc} = 15\ A$ |
| RDF (Rated Diversity Factor) | 1 |



To protect from unauthorised access



Sealing cap
Mi PL 2



Lid fastener for
tool operation
Mi DR 04



Mi PV 3311

6 x PV string for 1 x inverter input
2 x DC generator disconnect switch

- + ready for connection
- + 6 x fuse holders + and - each, for cylindrical fuse links gPV 10x38, connection: 1.5-16 mm² Cu
- + DC generator circuit breaker usage category for switch disconnectors: DC 21A = switching resistive load including moderate overload
- + Connection 6-35 mm², Cu
- + Lid fasteners for tool operation
- + included cable entries: 12 x AKM 16, 2 x AKM 25
- + with stainless steel external brackets

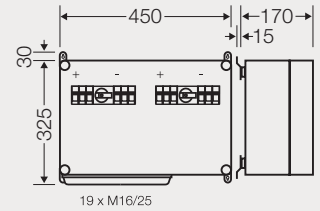

| | |
|---|-----------------------------|
| Rated voltage | $U_{OC\ STC} = 1000\ V\ DC$ |
| Rated current of the switchgear combination | $I_{nA} = 60\ A$ |
| Rated current of a circuit | $I_{nc} = 10\ A$ |
| RDF (Rated Diversity Factor) | 1 |



Mi PV 3321

6 x PV string for 1 x inverter input
1 x type 2 DC surge arrester and
2 x DC generator disconnect switch

- + ready for connection
- + 6 x fuse holders + and - each, for cylindrical fuse links gPV 10x38, connection: 1.5-16 mm² Cu
- + DC generator circuit breaker usage category for switch disconnectors: DC 21A = switching resistive load including moderate overload
- + Connection 6-35 mm², Cu
- + DC surge arrester type 2
Limit leakage surge current DC (8/20) I_{total} : 40 kA
DC protection level: < 4 kV
- + Rated connecting capacity PE: 1.5-35 mm² Cu
- + Lid fasteners for tool operation
- + included cable entries: 12 x AKM 16, 2 x AKM 25
- + with stainless steel external brackets

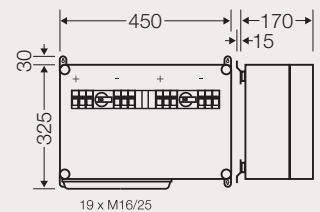

| | |
|---|-----------------------------|
| Rated voltage | $U_{OC\ STC} = 1000\ V\ DC$ |
| Rated current of the switchgear combination | $I_{nA} = 60\ A$ |
| Rated current of a circuit | $I_{nc} = 10\ A$ |
| RDF (Rated Diversity Factor) | 1 |





Mi PV 3611

12 x PV strings to 1 x inverter input
1 x DC generator circuit breaker

- + ready for connection
- + 12 x fuse holders + and - each, for cylindrical fuse links gPV 10x38, connection: 1.5-16 mm² Cu
- + DC generator circuit breaker
Connection: M 10 (max. 1 x 120 mm² per pole)
- + Lid fasteners for tool operation
- + included cable entries: 12 x AKM 16, 12 x AKM 20, 2 x AKM 25
- + with stainless steel external brackets

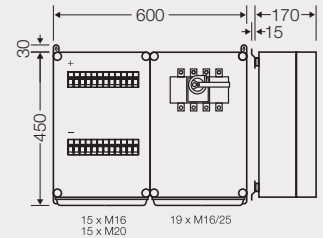

| | |
|---|-----------------------------|
| Rated voltage | $U_{OC\ STC} = 1000\ V\ DC$ |
| Rated current of the switchgear combination | $I_{nA} = 120\ A$ |
| Rated current of a circuit | $I_{nc} = 10\ A$ |
| RDF (Rated Diversity Factor) | 1 |



Mi PV 3621

12 x PV strings to 1 x inverter input
1 x type 2 DC surge arrester and
1 x DC generator circuit breaker

- + ready for connection
- + 12 x fuse holders + and - each, for cylindrical fuse links gPV 10x38, connection: 1.5-16 mm² Cu
- + DC generator circuit breaker
Connection: M 10 (max. 1 x 120 mm² per pole)
- + DC surge arrester type 2
Limit leakage surge current DC (8/20) I_{total} : 40 kA
DC protection level: < 4 kV
- + Rated connecting capacity PE: 1.5-35 mm² Cu
- + Lid fasteners for tool operation
- + included cable entries: 12 x AKM 16, 12 x AKM 20, 3 x AKM 25
- + with stainless steel external brackets

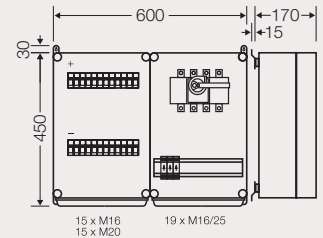

| | |
|---|-----------------------------|
| Rated voltage | $U_{OC\ STC} = 1000\ V\ DC$ |
| Rated current of the switchgear combination | $I_{nA} = 120\ A$ |
| Rated current of a circuit | $I_{nc} = 10\ A$ |
| RDF (Rated Diversity Factor) | 1 |





Mi PV 3931

24 x PV strings to 1 x inverter input
1 x DC generator circuit breaker

- + ready for connection
- + 24 x fuse holders + and - each, for cylindrical fuse links gPV 10x38, connection: 1.5-16 mm² Cu
- + DC generator circuit breaker
Connection: M 10 (max. 1 x 120 mm² per pole)
- + Lid fasteners for tool operation
- + included cable entries: 24 x AKM 16, 24 x AKM 20, 2 x AKM 40
- + with stainless steel external brackets

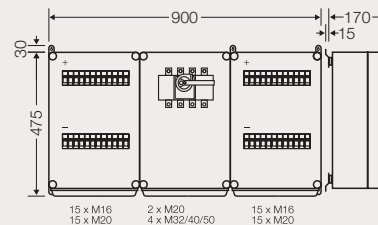

| | |
|---|-----------------------------|
| Rated voltage | $U_{OC\ STC} = 1000\ V\ DC$ |
| Rated current of the switchgear combination | $I_{nA} = 240\ A$ |
| Rated current of a circuit | $I_{nc} = 10\ A$ |
| RDF (Rated Diversity Factor) | 1 |





Mi PV 3941

24 x PV strings to 1 x inverter input
 1 x type 2 DC surge arrester and
 1 x DC generator circuit breaker

- + ready for connection
- + 24 x fuse holders + and - each,
 for cylindrical fuse links gPV 10x38,
 connection: 1.5-16 mm² Cu
- + DC generator circuit breaker
 Connection: M 10 (max. 1 x 120 mm² per pole)
- + DC surge arrester type 2
 Limit leakage surge current DC (8/20) I_{total}: 40 kA
 DC protection level: < 4 kV
- + Rated connecting capacity PE: 1.5-35 mm² Cu
- + Lid fasteners for tool operation
- + included cable entries: 24 x AKM 16, 24 x AKM 20,
 2 x AKM 40
- + with stainless steel external brackets

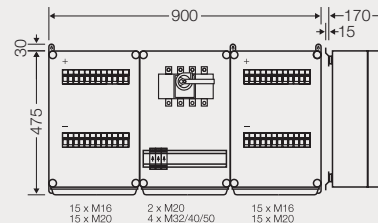

| | |
|---|---------------------------------|
| Rated voltage | U _{OC STC} = 1000 V DC |
| Rated current of the switchgear combination | I _{nA} = 240 A |
| Rated current of a circuit | I _{nc} = 10 A |
| RDF (Rated Diversity Factor) | 1 |



Accessories to reduce condensed water



Dewguard



Pressure equalising element BM xxG



Canopy MI DB ...



Ventilation flange MI BF 44

PHOTOVOLTAIC
CONNECTION BOXES UP TO 1500 V DC
MADE OF INSULATING MATERIAL IN
PROTECTION CLASS II,
DEGREE OF PROTECTION
UP TO IP 65



Would you like to find out more
about HENSEL?

hensel.in

INDIVIDUAL SOLUTIONS?
TALK TO US!



ENYSUN PV INVERTER COLLECTOR



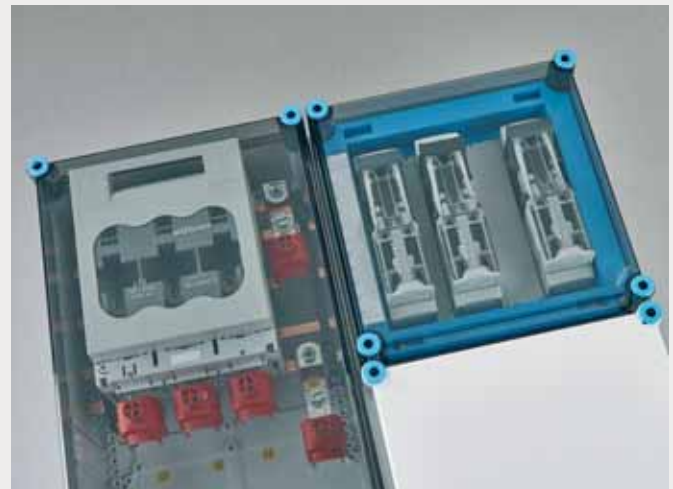
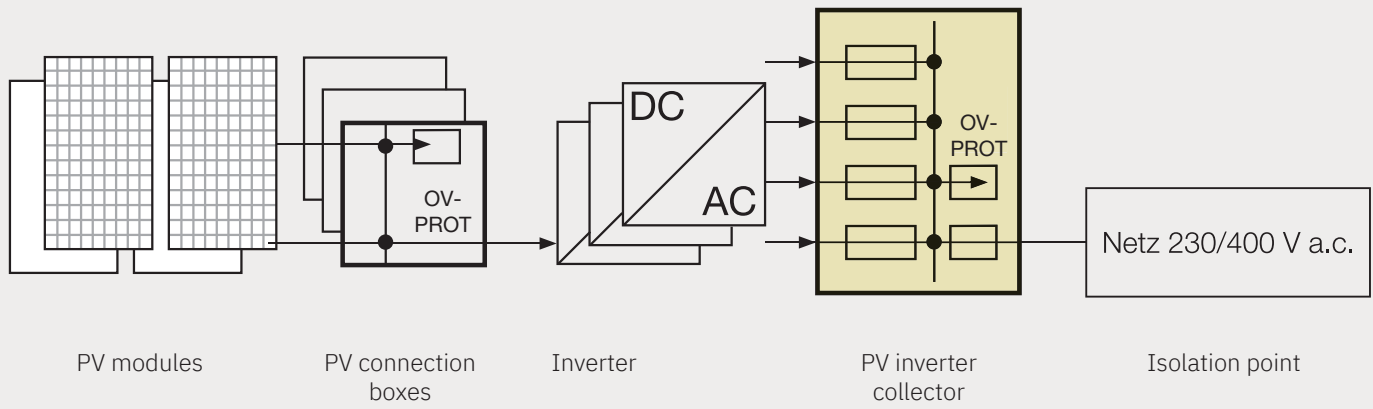

System properties

- + Ready-to-connect delivery: installed, wired and tested.
- + Electrical data:
 - Rated voltage: 230/400 V AC
 - Rated power: up to 350 kVA
 - Degree of protection: up to IP 54
 - Optionally with surge arrester
- + Derating: consideration of thermal effects for generating installations

More information about these products:
hensel.in

ENYSUN PV INVERTER COLLECTOR

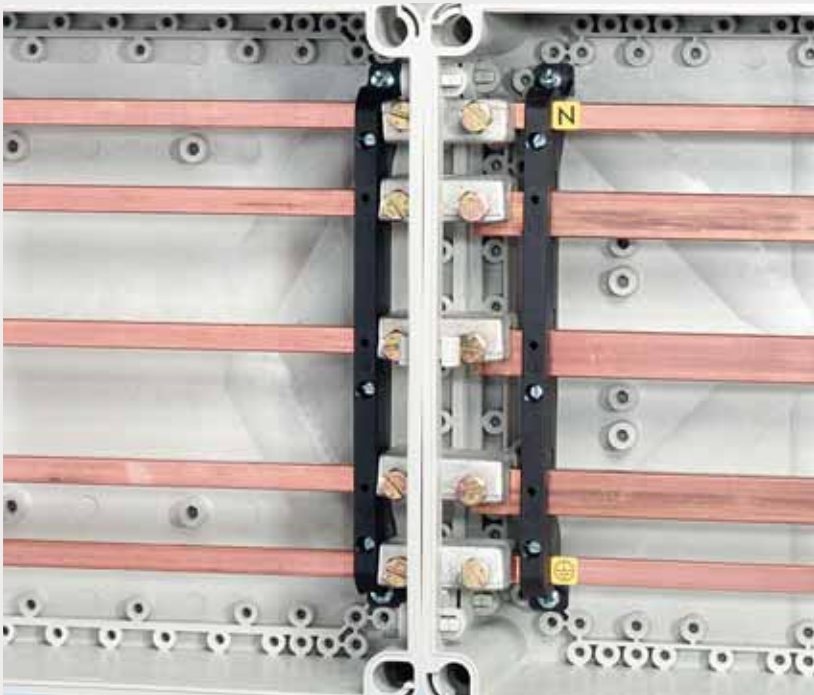

EMC-compliant busbar

The main busbar system has the N/PEN conductors in the area of the outer conductors as standard. The N busbars have the same current carrying capacity as the external conductors.

These busbars are suitable for:

- harmonics generated by inverters.
- asymmetric loads (asymmetric load limit 4.6 kVA permitted by the energy supplier) due to different external conductor loads.





Connection of large cable cross-sections

All PV inverter collectors are equipped with cable entries for large cross-sections in HRC fuse switch disconnectors from HRC1 onwards. To facilitate connection, the existing mounting flanges can be replaced with a cable insert.

The cables are inserted from the front.

This means that the cables do not have to be inserted through a cable screw gland.

The cable strain relief clamp always holds the connected cables centred in the stepped grommets to maintain the degree of protection. In addition, the cables are relieved of compression and tension.

INDIVIDUAL SOLUTIONS?
TALK TO US!



ENYSUN

INSTALLATION OPTIONS FOR A PV INVERTER COLLECTOR

All PV inverter collectors can be extended and combined with Mi distributor boards and accessories.



Empty boxes
for the installation of DIN rails and mounting plates



Boxes for Rail-mounted devices
e.g. for circuit breakers or residual current circuit breakers



Boxes for meter stations
for meters, transducers and measuring devices



Boxes for overvoltage protection
also for the pre-meter area



Boxes with busbars
with and without devices



Boxes with units on mounting plate
e.g. HRC fuses, switch disconnectors or circuit-breakers

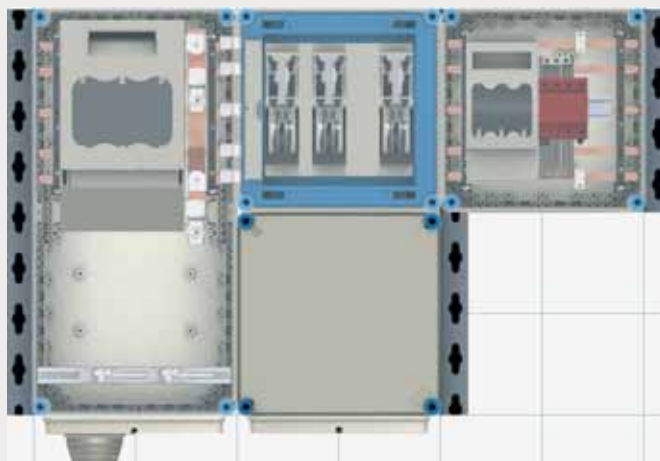

Example:
Extension of the PV inverter collector
Mi PV 7324 with
+ type 1 surge protection (Mi SP 2262)



Example:
Extension of the PV inverter collector
Mi PV 7324 with
+ Type 2 surge protection (Mi SP 2138)
+ Meter box for one ripple control receiver (Mi 2200)
+ Circuit breaker box for voltage path (Mi 1115)



Photovoltaic installations must be dimensioned differently.

Why are special solutions needed for PV systems?

The design or dimensioning of photovoltaic installations differs significantly from the usual building installation in that the installed devices are subjected to a continuous load.

Selection of the protective device

Building installation

Selection and dimensioning of the protective device to protect the line in relation to the current or the power of the consumer.

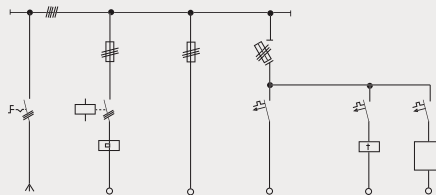

Photovoltaic system

Selection and dimensioning of the protective device to protect the line in relation to the current or the power of the inverter on the AC side.

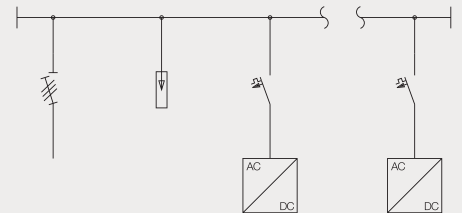

Consideration of the simultaneity factor

Due to the low simultaneity factor (0.3-0.6), the installation distribution board is often dimensioned according to the number of modules.

For PV systems, the simultaneity factor is 1! For this reason, the distribution board for PV systems must be dimensioned differently and not just according to the number of modules, for example.

Influence by heat from simultaneity factor and load

In consumer systems, the power dissipation fluctuates depending on the consumers that are switched on.

Continuously constant high loads result in an above-average power dissipation during the energy generation phase.

Low average effective power dissipation

The power dissipation must therefore be reduced to such an extent that the maximum permissible temperature for devices is not exceeded.

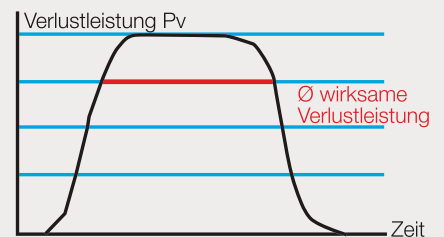
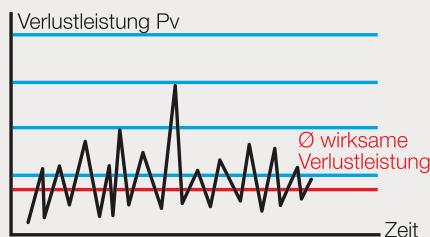

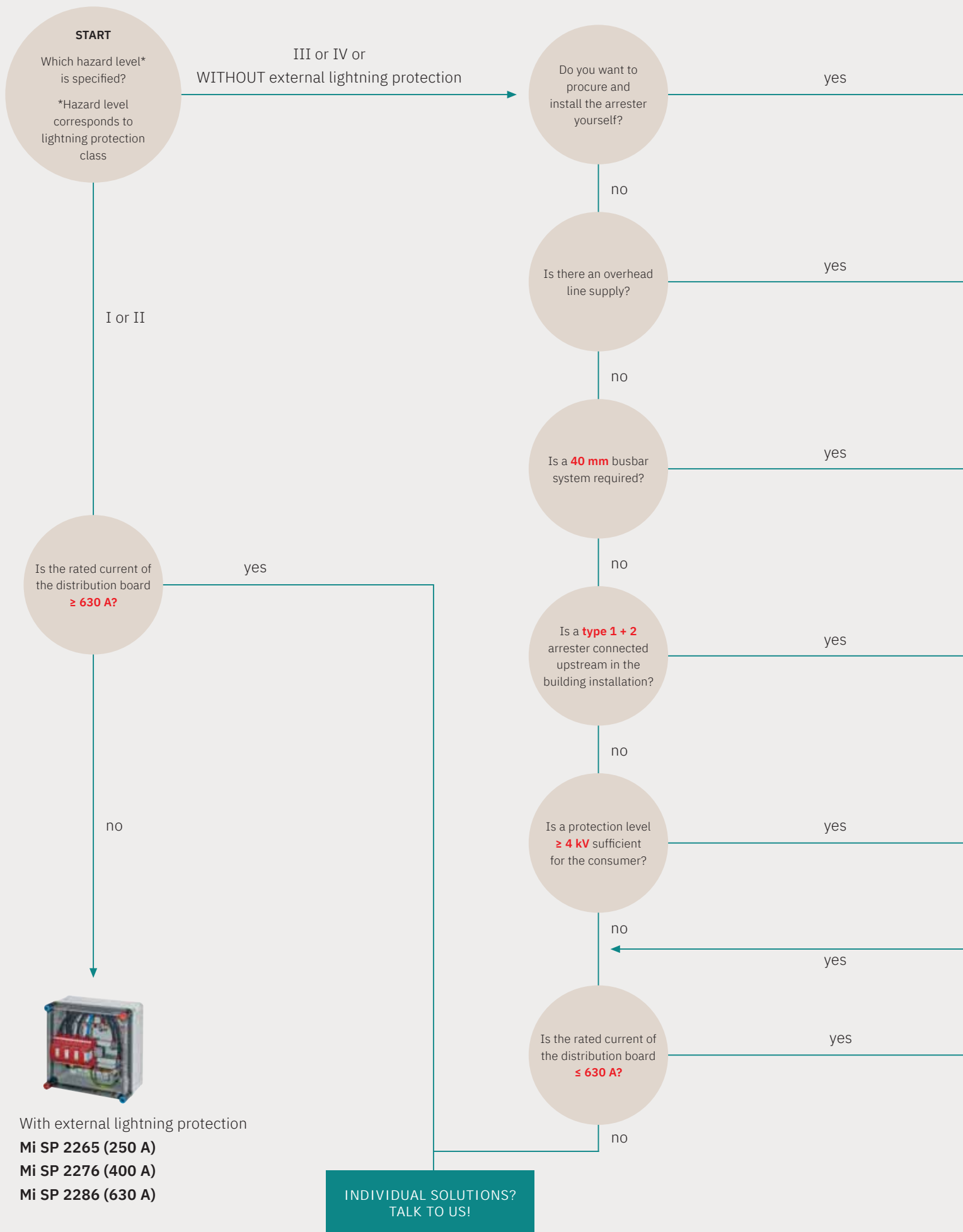

With external lightning protection
Mi SP 2265 (250 A)
Mi SP 2276 (400 A)
Mi SP 2286 (630 A)

**INDIVIDUAL SOLUTIONS?
TALK TO US!**

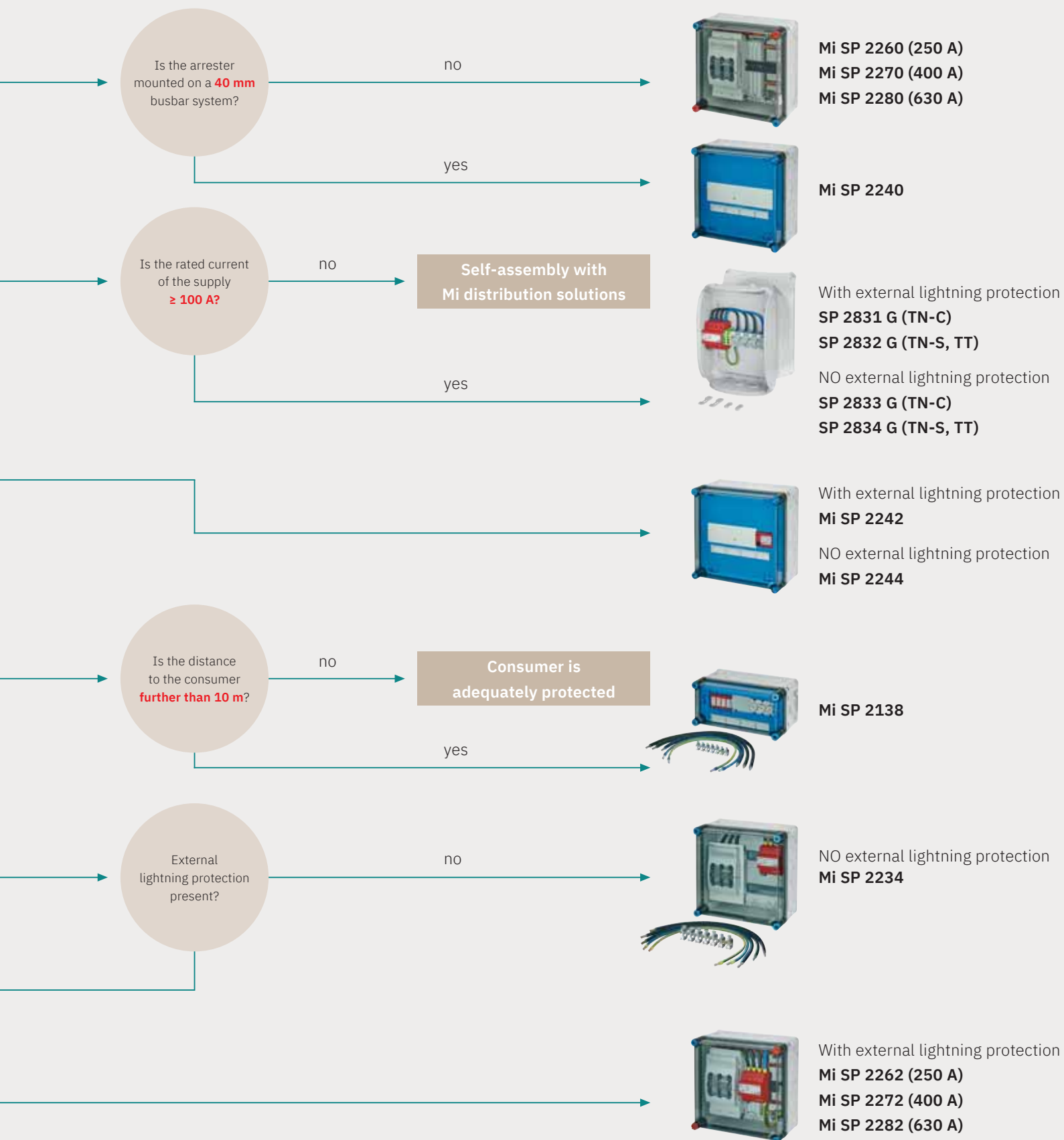

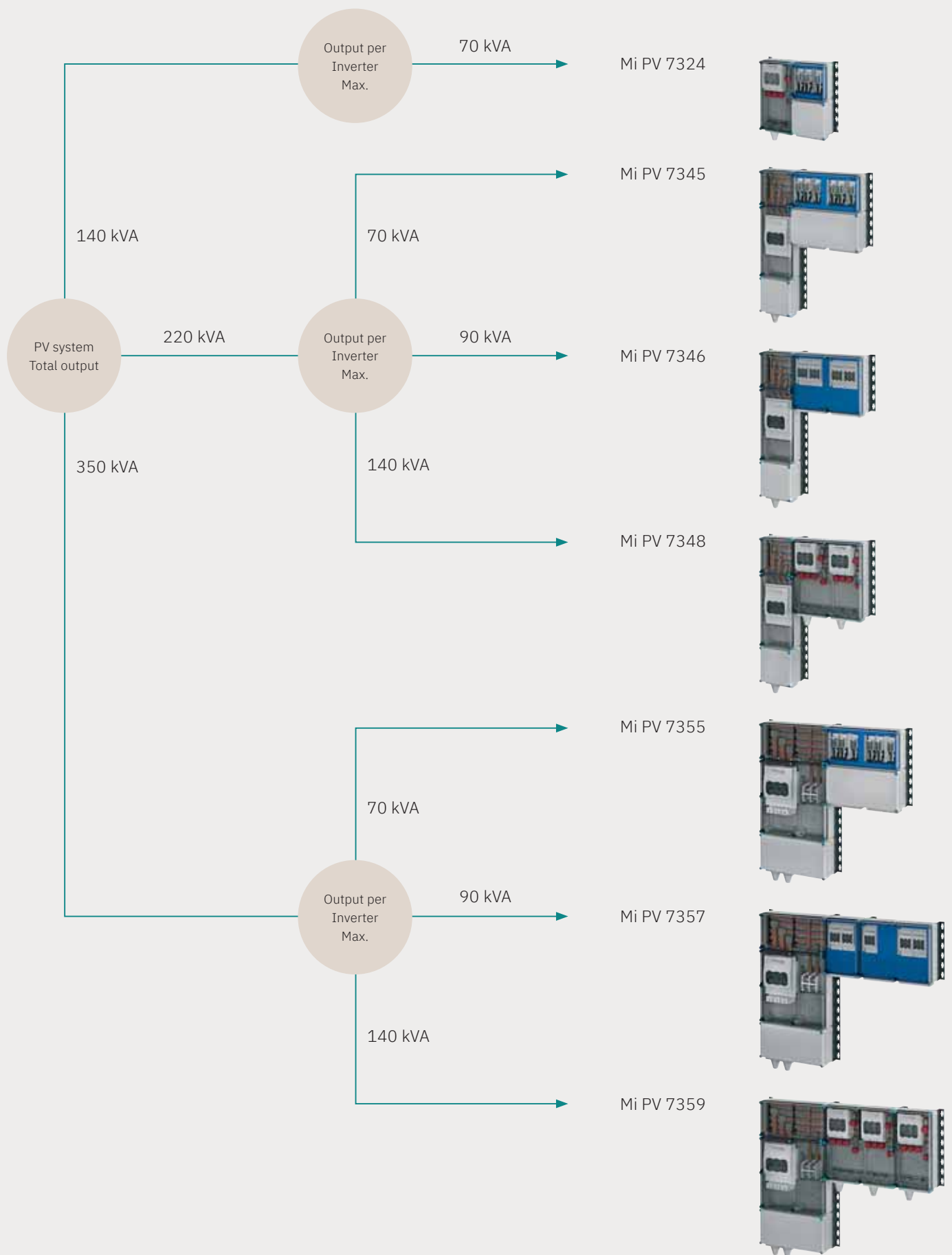



Mi PV 7324

Rated power 140 kVA

- + ready for connection
- + Incoming cables: for inverters up to 70 kVA, 3~
Rated operating current 100 A AC
per inverter
- + max. 3 x 3~ inverters
- + HRC 000 fuse switch disconnecter, 3-pole
Connection: 2.5-16 mm² per phase, single-strand, round, Cu
2.5-50 mm² per phase, multi-strand, round, Cu
1 terminal per PE+N, 4-35 mm², single- and multi-strand, round, Cu
- + Outgoing line: HRC 1 switch disconnectors, 3-pole with isolating blades
1 terminal per PE+N
Connection: 25-300 mm², single- and multi-strand, round and sector-shaped, Cu and Al
- + Supply and outgoing lines from below
- + Order cable entries separately
- + without fuse links
- + INV combiner mounted on mounting profile rail
- + Extendable with boxes and accessories from the Mi product range (ENYMOD)

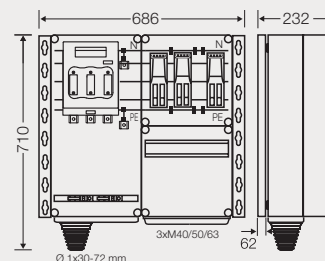

| | |
|---|---|
| Rated voltage | $U_n = 230/400 \text{ V AC}$ |
| Rated current of the switchgear combination | $I_{nA} = 200 \text{ A}$ |
| Rated current of a circuit | $I_{nc} = 100 \text{ A}$ The sum of the I_{nc} must not be greater than I_{nA} . |
| RDF (Rated Diversity Factor) | 1 |
| Rated short-time withstand current | $I_{cw} = 15 \text{ kA} / 1 \text{ s}$ with fuse links |





Mi PV 7345

Rated power 220 kVA

- + ready for connection
- + Incoming cables: for inverters up to 70 kVA, 3~
Rated operating current 100 A AC
per inverter
- + max. 6 x 3~ inverters
- + HRC 000 fuse switch disconnecter, 3-pole
Connection: 2.5-16 mm² per phase,
single-strand, round, Cu
2.5-50 mm² per phase, multi-strand, round, Cu
1 terminal per PE+N, 4-35 mm², single- and
multi-strand, round, Cu
- + Outgoing line: HRC 2 switch disconnectors,
3-pole with isolating blades
1 terminal per PE+N
Connection: 25-300 mm², single- and multi-strand,
round and sector-shaped, Cu and Al
- + Supply and outgoing lines from below
- + Order cable entries separately
- + without fuse links
- + INV combiner mounted on mounting profile rail
- + Extendable with boxes and accessories from the Mi product
range (ENYMOD)

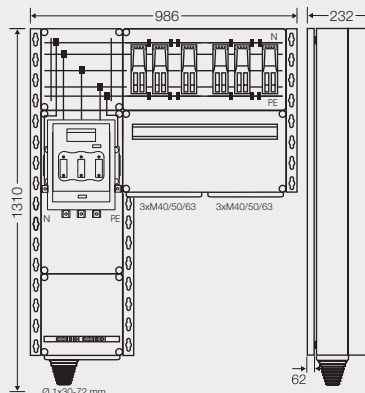

| | |
|---|---|
| Rated voltage | $U_n = 230/400 \text{ V AC}$ |
| Rated current of the switchgear combination | $I_{nA} = 320 \text{ A}$ |
| Rated current of a circuit | $I_{nc} = 100 \text{ A}$ The sum of the I_{nc} must not be greater than I_{nA} . |
| RDF (Rated Diversity Factor) | 1 |
| Rated short-time withstand current | $I_{cw} = 15 \text{ kA} / 1 \text{ s}$ with fuse links |





Mi PV 7355

Rated power 350 kVA

- + ready for connection
- + Incoming cables: for inverters up to 70 kVA, 3~ Rated operating current 100 A AC per inverter
- + max. 6 x 3~ inverters
- + HRC 000 fuse switch disconnector, 3-pole
Connection: 2.5-16 mm² per phase, single-strand, round, Cu
2.5-50 mm² per phase, multi-strand, round, Cu
1 terminal per PE+N, 4-35 mm², single- and multi-strand, round, Cu
- + Outgoing line: HRC 3 switch disconnectors, 3-pole with isolating blades
1 terminal per PE+N
Connection: 1x120-300 mm², multi-strand, round and sector-shaped, Cu and Al
2x95-185 mm², single- and multi-strand, sector-shaped, Cu and Al
- + Supply and outgoing lines from below
- + Order cable entries separately
- + without fuse links
- + INV combiner mounted on mounting profile rail
- + Extendable with boxes and accessories from the Mi product range (ENYMOD)

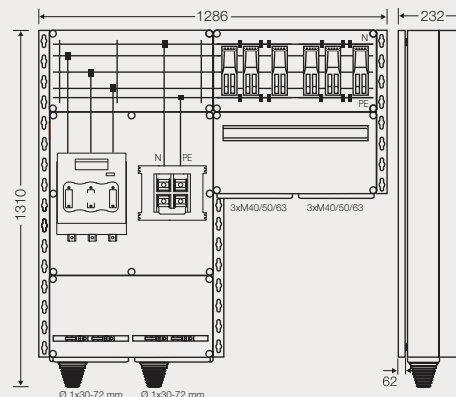

| | |
|---|---|
| Rated voltage | $U_n = 230/400 \text{ V AC}$ |
| Rated current of the switchgear combination | $I_{nA} = 500 \text{ A}$ |
| Rated current of a circuit | $I_{nc} = 100 \text{ A}$ The sum of the I_{nc} must not be greater than I_{nA} . |
| RDF (Rated Diversity Factor) | 1 |
| Rated short-time withstand current | $I_{cw} = 21 \text{ kA} / 1 \text{ s}$ with fuse links |





Mi PV 7346

Rated power 220 kVA

- + ready for connection
- + Incoming cables: for inverters up to 90 kVA, 3~
Rated operating current 128 A AC
per inverter
- + max. 4 x 3~ inverters
- + HRC 00 fuse switch disconnecter, 3-pole
Connection: 1.5-10 mm² per phase,
single-strand, round, Cu
16-70 mm² per phase, multi-strand, round, Cu
1 terminal per PE+N, 4-35 mm²,
single- and multi-strand, round, Cu
- + Outgoing line: HRC 2 switch disconnectors,
3-pole with isolating blades
1 terminal per PE+N
Connection: 25-300 mm², single- and multi-strand,
round and sector-shaped, Cu and Al
- + Supply and outgoing lines from below
- + Order cable entries separately
- + without fuse links
- + INV combiner mounted on mounting profile rail
- + Extendable with boxes and accessories from the Mi product
range (ENYMOD)

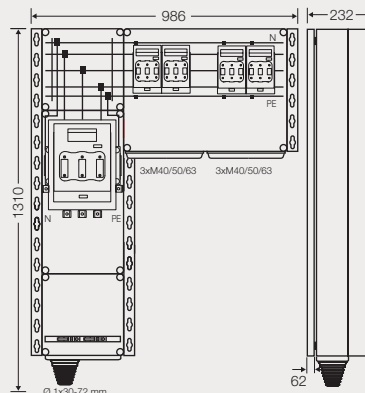

| | |
|---|---|
| Rated voltage | $U_n = 230/400 \text{ V AC}$ |
| Rated current of the switchgear combination | $I_{nA} = 320 \text{ A}$ |
| Rated current of a circuit | $I_{nc} = 128 \text{ A}$ The sum of the I_{nc} must not be greater than I_{nA} . |
| RDF (Rated Diversity Factor) | 1 |
| Rated short-time withstand current | $I_{cw} = 15 \text{ kA} / 1 \text{ s}$ with fuse links |





Mi PV 7357

Rated power 350 kVA

- + ready for connection
- + Incoming cables: for inverters up to 90 kVA, 3~Rated operating current 128 A AC per inverter
- + max. 5 x 3~ inverters
- + HRC 00 fuse switch disconnector, 3-pole
Connection: 1.5-10 mm² per phase, single-strand, round, Cu
16-70 mm² per phase, multi-strand, round, Cu
1 terminal per PE+N, 4-35 mm², single- and multi-strand, round, Cu
- + Outgoing line: HRC 3 switch disconnectors, 3-pole with isolating blades
1 terminal per PE+N
Connection: 1x120-300 mm², multi-strand, round and sector-shaped, Cu and Al
2x95-185 mm², single- and multi-strand, sector-shaped, Cu and Al
- + Supply and outgoing lines from below
- + Order cable entries separately
- + without fuse links
- + INV combiner mounted on mounting profile rail
- + Extendable with boxes and accessories from the Mi product range (ENYMOD)

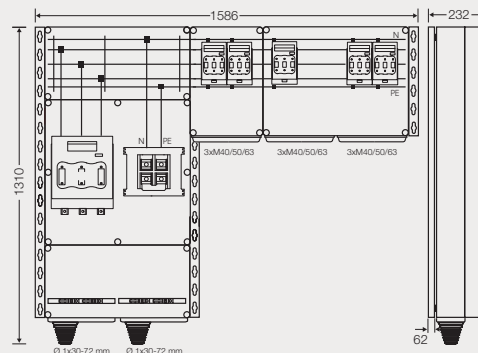

| | |
|---|---|
| Rated voltage | $U_n = 230/400 \text{ V AC}$ |
| Rated current of the switchgear combination | $I_{nA} = 500 \text{ A}$ |
| Rated current of a circuit | $I_{nC} = 128 \text{ A}$ The sum of the I_{nC} must not be greater than I_{nA} . |
| RDF (Rated Diversity Factor) | 1 |
| Rated short-time withstand current | $I_{cW} = 21 \text{ kA} / 1 \text{ s}$ with fuse links |





Mi PV 7348

Rated power 220 kVA

- + ready for connection
- + Incoming cables: for inverters up to 140 kVA, 3~
Rated operating current 200 A AC
per inverter
- + max. 2 x 3~ inverters
- + HRC 1 fuse switch disconnecter, 3-pole
1 terminal per PE+N
Connection: 25-300 mm², single- and multi-strand,
round and sector-shaped, Cu and Al
- + Outgoing line: HRC 2 switch disconnectors,
3-pole with isolating blades
1 terminal per PE+N
Connection: 25-300 mm², single- and multi-strand,
round and sector-shaped, Cu and Al
- + Supply and outgoing lines from below
- + without fuse links
- + INV combiner mounted on mounting profile rail
- + Extendable with boxes and accessories from the Mi product
range (ENYMOD)

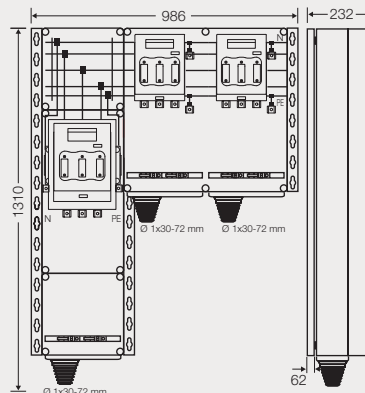

| | |
|---|---|
| Rated voltage | $U_n = 230/400 \text{ V AC}$ |
| Rated current of the switchgear combination | $I_{nA} = 320 \text{ A}$ |
| Rated current of a circuit | $I_{nc} = 200 \text{ A}$ The sum of the I_{nc} must not be greater than I_{nA} . |
| RDF (Rated Diversity Factor) | 1 |
| Rated short-time withstand current | $I_{cw} = 15 \text{ kA} / 1 \text{ s}$ with fuse links |





Mi PV 7359

Rated power 350 kVA

- + ready for connection
- + Incoming cables: for inverters up to 140 kVA, 3~Rated operating current 200 A AC per inverter
- + max. 3 x 3~ inverters
- + HRC 1 fuse switch disconnector, 3-pole
1 terminal per PE+N
Connection: 25-300 mm², single- and multi-strand, round and sector-shaped, Cu and Al
- + Outgoing line: HRC 3 switch disconnectors, 3-pole with isolating blades
1 terminal per PE+N
Connection: 1x120-300 mm², multi-strand, round and sector-shaped, Cu and Al
2x95-185 mm², single- and multi-strand, sector-shaped, Cu and Al
- + Supply and outgoing lines from below
- + without fuse links
- + INV combiner mounted on mounting profile rail
- + Extendable with boxes and accessories from the Mi product range (ENYMOD)

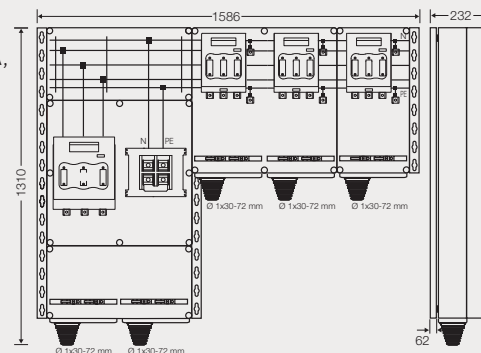

| | |
|---|---|
| Rated voltage | $U_n = 230/400 \text{ V AC}$ |
| Rated current of the switchgear combination | $I_{nA} = 500 \text{ A}$ |
| Rated current of a circuit | $I_{nc} = 200 \text{ A}$ The sum of the I_{nc} must not be greater than I_{nA} . |
| RDF (Rated Diversity Factor) | 1 |
| Rated short-time withstand current | $I_{cw} = 21 \text{ kA} / 1 \text{ s}$ with fuse links |



PHOTOVOLTAIC INVERTER COLLECTOR UP TO 560 kVA MADE OF INSULATING MATERIAL IN PROTECTION CLASS II, DEGREE OF PROTECTION UP TO IP 65



ENYSUN ACCESSORIES

For further accessories for ENYSUN photovoltaic solutions,
see the Hensel main catalogue - Mi tab.

For cable entries, see the Hensel main catalogue - LES tab.





DA 300

Terminal for direct connection up to 400 A
max. 300 mm²

- + for mounting onto switchgear with flat contact M10
- + with insulating cover
- + Rated connecting capacity: 25-300 mm² s/sol, Cu/Alu
- + Aluminium conductors must be prepared before connection according to the relevant technical recommendations: see technical information on aluminium conductors.

| | |
|-------------------------------|---------|
| Tightening torque of terminal | 32.0 Nm |
|-------------------------------|---------|



MS HRC 00

Fuse switch disconnectors 160 A, HRC 00,
3-pole for mounting on busbars

- + for replacement and supplementation in Mi fuse boxes
- + Height: 200 mm x width: 106 mm
- + Connection: 1.5-70 mm², Cu, round conductor
connection to wiring strip Mi VS 100/160

| | |
|-------------------------------|---------------------------|
| Rated voltage | U _n = 690 V AC |
| Busbar thickness | 10 mm |
| Centreline spacing of busbars | 60 mm |
| Tightening torque of terminal | 6.0 Nm frame terminal |



Mi BA 6

Blanking cover in Mi-HRC 00 screw-type fuse box

- + for closing covers
- + Width: 108 mm



Mi WD 2

Wall gasket for box walls 150/300 mm

- + for the assembly of Mi boxes
- + consists of 1 seal, 4 wedge connectors, 1 clamp

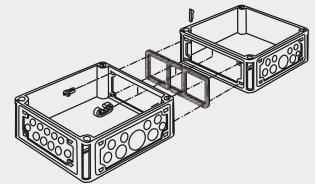

Mi SV 25

Busbar connector for busbars 250 A, 5-pole

- + with wall gasket
- + for the assembly of Mi boxes containing busbars
- + Busbars 250 A and 400 A can be connected with busbar connector Mi SV 25. Connection of busbars with different rated currents only under consideration of corresponding short-circuit and overload conditions.



| | |
|-------------------------------|--------|
| Tightening torque of terminal | 6.0 Nm |
|-------------------------------|--------|



Mi SV 45

Busbar connector for busbars 400/630 A, 5-pole

- + with wall gasket
- + for the assembly of Mi boxes containing busbars

| | |
|-------------------------------|---------|
| Tightening torque of terminal | 10.0 Nm |
|-------------------------------|---------|



AS 12

Blanking strip 12 modules

- + 12 x 18 mm, divisible every 9 mm
- + For closing unused device cut-outs, for material thickness up to 3 mm



Mi FM 25

Mounting flange, knockout 19 x M 16/25

- + Box wall 300 mm
- + with fixing wedges and seal



Mi FM 32

Mounting flange,
knockout 8 x M 25/32, 1 x M 25/32/40

- + Box wall 300 mm
- + with fixing wedges and seal



Mi FM 40

Mounting flange,
knockout 2 x M 25/32, 5 x M 32/40

- + Box wall 300 mm
- + with fixing wedges and seal



Mi FM 50

Mounting flange,
knockout 2 x M 20, 4 x M 32/40/50

- + Box wall 300 mm
- + with fixing wedges and seal



Mi FM 60

Mounting flange, knockout 3 x M 40/50/63

- + Box wall 300 mm
- + with fixing wedges and seal



Mi FP 70

Cable entry flange
sealing range 1 x Ø 30-72 mm

- + Box wall 300 mm
- + with fixing wedges and seal

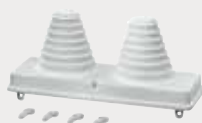

Mi FP 72

Cable entry flange
sealing range 2 x Ø 30-72 mm

- + Box wall 300 mm
- + with fixing wedges and seal



Mi FM 63

Mounting flange with room for manoeuvre
Knockout 3 x M 40/50/63

- + Box wall 300 mm
- + with fixing wedges and seal

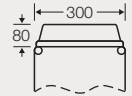

Mi FP 82

Cable insert
sealing range 2 x each Ø 30-72 mm

- + Box wall 300 mm
- + Divisible
- + Degree of protection IP 54 only when using additional strain and pressure relief (e.g. Mi ZE 62)

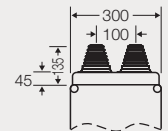

Mi ZE 62

Cable strain relief clamp
for 2 cables max. Ø 60 mm

- + with fixing rail 284 mm long
- + to be used only in connection with cable insertion Mi FP 82



AKM 12

Mounted cable glands for M 12 knockouts

- + Sealing range \varnothing 4-6 mm
- + ISO thread M 12 x 1.5
- + Bore-hole \varnothing 12.3 mm
- + Wall thickness up to 3 mm, with strain relief and locknut
- + For indoors and protected outdoor installation
- + Ambient temperature - 25 °C to + 55 °C
- + Glow wire test IEC 60695-2-11: 960 °C
- + Colour: grey, RAL 7035



IP
66/67

IP
69

| | |
|-------------------|--------|
| Tightening torque | 0.9 Nm |
|-------------------|--------|



AKM 16

Mounted cable glands for knockouts M 16

- + Sealing range \varnothing 5-10 mm
- + ISO thread M 16 x 1.5
- + Bore-hole \varnothing 16.3 mm
- + Wall thickness up to 3 mm, with strain relief and locknut
- + For indoors and protected outdoor installation
- + Ambient temperature - 25 °C to + 55 °C
- + Glow wire test IEC 60695-2-11: 960 °C
- + Colour: grey, RAL 7035



IP
66/67

IP
69

| | |
|-------------------|--------|
| Tightening torque | 3.0 Nm |
|-------------------|--------|



AKM 20

Mounted cable glands for M 20 knockouts

- + Sealing range \varnothing 6.5-13.5 mm
- + ISO thread M 20 x 1.5
- + Bore-hole \varnothing 20.3 mm
- + Wall thickness up to 3 mm, with strain relief and locknut
- + For indoors and protected outdoor installation
- + Ambient temperature - 25 °C to + 55 °C
- + Glow wire test IEC 60695-2-11: 960 °C
- + Colour: grey, RAL 7035



IP
66/67

IP
69

| | |
|-------------------|--------|
| Tightening torque | 4.0 Nm |
|-------------------|--------|



AKM 25

Mounted cable glands for M 25 knockouts

- + Sealing range \varnothing 11-17 mm
- + ISO thread M 25 x 1.5
- + Bore-hole \varnothing 25.3 mm
- + Wall thickness up to 3 mm, with strain relief and locknut
- + For indoors and protected outdoor installation
- + Ambient temperature - 25 °C to + 55 °C
- + Glow wire test IEC 60695-2-11: 960 °C
- + Colour: grey, RAL 7035



IP
66/67

IP
69

| | |
|-------------------|--------|
| Tightening torque | 7.5 Nm |
|-------------------|--------|



AKM 32

Mounted cable glands for M 32 knockouts

- + Sealing range Ø 15-21 mm
- + ISO thread M 32 x 1.5
- + Bore-hole Ø 32.3 mm
- + Wall thickness up to 3 mm, with strain relief and locknut
- + For indoors and protected outdoor installation
- + Ambient temperature - 25 °C to + 55 °C
- + Glow wire test IEC 60695-2-11: 960 °C
- + Colour: grey, RAL 7035



IP
66/67

IP
69

| | |
|-------------------|---------|
| Tightening torque | 10.0 Nm |
|-------------------|---------|



AKM 40

Mounted cable glands for M 40 knockouts

- + Sealing range Ø 19-28 mm
- + ISO thread M 40 x 1.5
- + Bore-hole Ø 40.3 mm
- + Wall thickness up to 3 mm, with strain relief and locknut
- + For indoors and protected outdoor installation
- + Ambient temperature - 25 °C to + 55 °C
- + Glow wire test IEC 60695-2-11: 960 °C
- + Colour: grey, RAL 7035



IP
66/67

IP
69

| | |
|-------------------|---------|
| Tightening torque | 10.0 Nm |
|-------------------|---------|



AKM 50

Mounted cable glands for knockouts M 50

- + Sealing range Ø 27-35 mm
- + ISO thread M 50 x 1.5
- + Bore-hole Ø 50.3 mm
- + Wall thickness up to 3 mm, with strain relief and locknut
- + For indoors and protected outdoor installation
- + Ambient temperature - 25 °C to + 55 °C
- + Glow wire test IEC 60695-2-11: 960 °C
- + Colour: grey, RAL 7035



IP
66/67

IP
69

| | |
|-------------------|---------|
| Tightening torque | 10.0 Nm |
|-------------------|---------|



AKM 63

Mounted cable glands for knockouts M 63

- + Sealing range Ø 35-42 mm
- + ISO thread M 63 x 1.5
- + Bore-hole Ø 63.3 mm
- + Wall thickness up to 3 mm, with strain relief and locknut
- + For indoors and protected outdoor installation
- + Ambient temperature - 25 °C to + 55 °C
- + Glow wire test IEC 60695-2-11: 960 °C
- + Colour: grey, RAL 7035



IP
66/67

IP
69

| | |
|-------------------|---------|
| Tightening torque | 10.0 Nm |
|-------------------|---------|

IP
44



Mi BF 44

Ventilation flange for installation
on box walls

- + Box wall 300 mm
- + for ventilation of Mi distributors at extremely high interior temperatures or where there is a risk of condensation formation

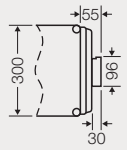

IP
44



BE 44

Ventilation insert



IP
54



BM 20G

Pressure equalising element for M 20 knockouts

- + to reduce condensation through pressure compensation in distribution systems.
- + ISO thread M 20 x 1.5
- + Bore-hole Ø 20.3 mm
- + Wall thickness up to 4 mm, with locknut
- + For indoors and protected outdoor installation
- + Ambient temperature - 25 °C to + 55 °C
- + To ensure that the leakage limit of 0.07 bar is not exceeded during pressure compensation, a BM 20G pressure equalisation element must be used for every 28 litres (28,000 cm³) of box volume.
- + Example: Box 30 cm x 60 cm x 17 cm = 30,600 cm³ = 30.6 litres.
- + Subject to technical changes without notice
- + Colour: grey, RAL 7035

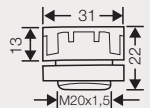

IP
54



BM 40G

Pressure equalisation element for M 40 knockouts

- + to reduce condensation through pressure compensation in distribution systems.
- + ISO thread M 40 x 1.5
- + Bore-hole Ø 40.3 mm
- + Wall thickness up to 8 mm, with locknut
- + For indoors and protected outdoor installation
- + Ambient temperature - 25 °C to + 55 °C
- + To ensure that the leakage limit of 0.07 bar is not exceeded during pressure compensation, a BM 40G pressure equalisation element must be used for every 122 litres (122,000 cm³) of box volume.
- + Example: Box 60 cm x 60 cm x 17 cm = 61,200 cm³ = 61.2 litres.
Number of BM 40G required = 1 item
- + Subject to technical changes without notice
- + Colour: grey, RAL 7035

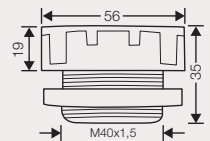

Application



Ventilation via ventilation
flange or insert



Pressure equalising
element

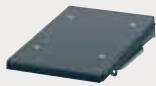

Mi DB 15

Canopy for box wall 150 mm

- + with fixing wedges and seal
- + suitable for unprotected outdoor installation, UV-resistant
(see operating and ambient conditions in the Technical Appendix)

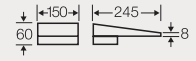

| | |
|----------|--------------------------------|
| Material | Stainless steel, powder-coated |
|----------|--------------------------------|

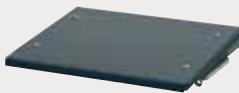

Mi DB 30

Canopy for box wall 300 mm

- + with fixing wedges and seal
- + suitable for unprotected outdoor installation, UV-resistant
(see operating and ambient conditions in the Technical Appendix)

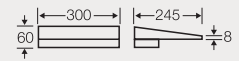

| | |
|----------|--------------------------------|
| Material | Stainless steel, powder-coated |
|----------|--------------------------------|

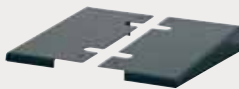

Mi DB 01

Canopy end angle

- + for canopies FP DB xx and Mi DB xx

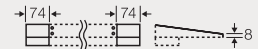

| | |
|----------|--------------------------------|
| Material | Stainless steel, powder-coated |
|----------|--------------------------------|



Mi PL 2

Sealing cap

- + 2 sealing caps for converting the lid fasteners



Mi SR 4

Conversion kit from manual to tool operation

- + 4 fastening covers



Mi SN 4

Conversion kit from tool to manual operation

- + 4 manual operations



Mi DV 01

Locking device insertion

- + only in connection with Mi PL 2, Mi SR 4, Mi SN 4 or Mi SV 2



Mi DR 04

Lid fastener for tool operation triangle 8 mm

- + Used in place of the manual or tool-operated fastener to prevent unauthorised opening of the lids.
- + 4 locking devices with triangle 8 mm and key



DS 1

Triangular key 8 mm

- + for box sizes 1 to 6
- + for 2 lid attachment tubes



Mi SA 2

Dust protection cover

- + for box sizes 1 to 6
- + for 2 lid attachment tubes



HDG 050

Dew guard

- + Absorbs moisture without any saturation, even in high humidity
- + Absorbency of 0.8g (H₂O) / 1g (product) 25 °C and 95% relative humidity or higher
- + Works between a large temperature range of - 30 °C to + 90 °C

| | |
|---------------------------|----------------------|
| width | 50 mm |
| height | 75 mm |
| volume | 7,500 m ³ |
| water absorption capacity | 1.9 g |



HDG 075

Dew guard

- + Absorbs moisture without any saturation, even in high humidity
- + Absorbency of 0.8g (H₂O) / 1g (product) 25 °C and 95% relative humidity or higher
- + Works between a large temperature range of - 30 °C to + 90 °C

| | |
|---------------------------|-----------------------|
| width | 75 mm |
| height | 100 mm |
| volume | 15,000 m ³ |
| water absorption capacity | 1.9 g |



HDG 100

Dew guard

- + Absorbs moisture without any saturation, even in high humidity
- + Absorbency of 0.8g (H₂O) / 1g (product) 25 °C and 95% relative humidity or higher
- + Works between a large temperature range of - 30 °C to + 90 °C

| | |
|---------------------------|-----------------------|
| width | 100 mm |
| height | 150 mm |
| volume | 30,000 m ³ |
| water absorption capacity | 1.9 g |



HDG 150

Dew guard

- + Absorbs moisture without any saturation, even in high humidity
- + Absorbency of 0.8g (H₂O) / 1g (product) 25 °C and 95% relative humidity or higher
- + Works between a large temperature range of - 30 °C to + 90 °C

| | |
|---------------------------|-----------------------|
| width | 150 mm |
| height | 150 mm |
| volume | 45,000 m ³ |
| water absorption capacity | 1.9 g |



Mi AL 40

4 stainless steel external brackets

+ for external box fastening

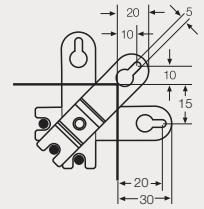

Mi MS 2

Wall mounting profile rail

+ for Mi distribution board assemblies up to 900 x 1200 mm

+ with 8 M6 x 16 screws, washers and nuts
for attaching the box

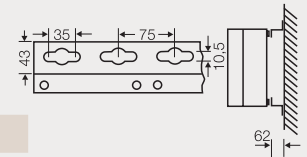

| | |
|----------|--|
| Length | 1950 mm |
| Material | Steel profile sendzimir-galvanised and coated with structural powder |

ENYSUN TECHNICAL APPENDIX



| Products | Material used | Glow wire test IEC 60695-2-11 | UL Subject 94 | Temperature resistance | Chemical resistance ¹⁾ | | | | | |
|---|---|-------------------------------|---------------|------------------------|-----------------------------------|------------|---------|----------------------------|-----------------------------|-------------|
| | | | | | Acid 10% | Alkali 10% | Alcohol | Petrol (MAC) ²⁾ | Benzene (MAC) ²⁾ | Mineral oil |
| Mi bottom parts ... | PC (polycarbonate) (with GFS) | 960 °C | V-0 | - 40 °C / + 120 °C | + | + | 0 | + | - | + |
| Mi lid ... Small distribution board door and flap ... | PC (polycarbonate) | 960 °C | V-0 | - 40 °C / + 120 °C | + | + | 0 | + | - | + |
| Small distribution board ... | PS (polystyrene) | 750 °C | V-2 | - 40 °C / + 70 °C | + | + | + | - | - | 0 |
| Small distribution board seal ... / Mi FP ... | TPE (thermoplastic elastomer) | 750 °C | - | - 25 °C / + 100 °C | + | + | + | 0 | 0 | 0 |
| Small distribution board seal ... / Mi ... | PUR (polyurethane) | - | - | - 25 °C / + 80 °C | 0 | + | 0 | 0 | - | + |
| AKM ... / BM ... | PA (polyamide) | 960 °C | V-0 | - 40 °C / + 100 °C | + | 0 | + | + | + | + |
| AKM seal ... | CR/NBR (polychloroprene nitrile rubber) | - | - | - 20 °C / + 100 °C | + | + | + | 0 | - | 0 |
| (+ = stable; 0 = conditionally stable; - = unstable) | | | | | | | | | | |

1) The information on chemical resistance is used for orientation. In individual cases, a check in conjunction with other chemicals and environmental conditions (temperature, concentration etc.) is required.

2) (MAC) - maximum allowable (workplace) concentration

| | KV PV ... Mi PV ... Mi AE ... | AKM mounted cable glands |
|---|---|-----------------------------|
| Field of application | Suitable for indoor and protected outdoor installation in accordance with DIN VDE 0100, part 737 However, the climatic effects on the installed equipment must be considered, for example high or low ambient temperatures or condensation water formation (see technical information). | |
| Ambient temperature | + 35 °C | + 55 °C |
| + Average value over 24 hours | + 40 °C | + 70 °C |
| + Maximum value | - 5 °C | - 25 °C |
| + Minimum value | | |
| Relative humidity | 50% at 40 °C | |
| + for a short time | 100% at 25 °C | |
| Fire protection for internal faults | Demands placed on electrical devices from standards and laws Minimum requirements - Glow wire test in accordance with IEC 60695-2-11: - 650 °C for box and cable entries - 850 °C for live parts | |
| Burning behaviour | 960 °C | 960 °C |
| + Glow wire test | V-2 | V-0 |
| IEC 60 695-2-11 | Flame-retardant | Flame-retardant |
| + UL Subject 94 | Self-extinguishing | Self-extinguishing |
| Degree of protection against mechanical stress | IK 08 (5 joules) | |
| Toxic behaviour | Halogen-free Silicone-free | |
| | ¹⁾ "Halogen-free" according to the test on cables and insulated lines - corrosivity of combustion gases - according to IEC 754-2. | |

**PV connection boxes,
PV inverter collectors and isolators
meet the requirements for power
switchgear combinations (PSC)
in accordance with IEC 61439-2
standards and regulations**

Switchgear combinations are switchgear assemblies that are assembled and wired without any significant deviation from the original type or system as specified by the original manufacturer. In order to meet these conditions for Hensel Mi distributors, the following must be observed:

- 1 The switchgear must consist of the enclosures documented in this list.
- 2 The wiring of the equipment must be carried out using the conductor cross-sections and conductor types specified in the table “Design of insulated conductors in switchgear” (see main catalogue, Technical tab or www.hensel-electric.de).
- 3 After completion of the switchgear, a routine test must be carried out in accordance with this standard.
- 4 This test must be certified with a test report.
- 5 The switchgear must be marked with a manufacturer’s identification. Compliance with key metrics such as e.g.
 - + the limit overtemperature
 - + the insulation strength
 - + the short-circuit withstand capacity
 - + the short-circuit withstand capacity of the protective conductor
 - + the IP degrees of protection
 - + the creepage distances and clearances etc.are proven for this system.

**Standards and
regulations**

- + IEC 61439-2
Low-voltage switchgear and controlgear assemblies (PSC)
- + IEC 60999
Electrical copper conductors - Safety requirements for screw-type and screwless-type clamping units
- + IEC 50262
Metric cable glands for electrical installations
- + IEC 60269
Low-voltage fuses
- + DIN 43880
Built-in equipment for electrical installations; overall dimensions and related mounting dimensions
- + IEC 60529
Degrees of protection provided by enclosures (IP Code)
- + DIN VDE 0100-712
Requirements for special installations or locations - Solar photovoltaic (PV) power supply systems

The external diameters are averages of various makes.

| Cable cross-section | NYM | NYY | NYCY | NAYY | Cable cross-section | NYM | NYY | NYCY | NAYY |
|---------------------|----------|-----------|-----------|-----------------|---------------------|-----------|-----------|-----------|-----------------|
| mm ² | mm Ø | mm Ø | mm Ø | mm ² | mm ² | mm Ø | mm Ø | mm Ø | mm ² |
| 1x4 | 6.4-6.6 | 9-9.1 | | | 4x1.5 | 8.8-9.8 | 12-13 | 13.2-13.5 | |
| 1x6 | 6.8-7.2 | 9-9.5 | | | 4x2.5 | 10.2-11.3 | 13.2-14 | 14.2-14.5 | |
| 1x10 | 8.8-8.4 | 10-10.2 | | | 4x4 | 12.1-13 | 15-16 | 16.5 | |
| 1x16 | 9.1-9.9 | 11-11.2 | | 10.5 | 4x6 | 16.1-17.6 | 16.3-17 | 17.5 | |
| 1x25 | 12-12.3 | 12-13 | | 12 | 4x10 | 19-21.3 | 18.5-19 | 19.5-20 | |
| 1x35 | | 13-14 | | 13-13.5 | 4x16 | 19-21.3 | 21-21.5 | 21.4-23 | 23-24 |
| 1x50 | | 15-16 | | 15,15.5 | 4x25 | 23.4-25.8 | 25.5-26 | 26 | 25-26 |
| 1x70 | | 16.4-17 | | 16.5-17 | 4x35 | 25.7-28.5 | 27.5-28 | 27.5 | 28-28.5 |
| 1x95 | | 18.5-19 | | 19 | 4x50 | | 29.8-30.5 | 29.5 | 29.5-30 |
| 1x120 | | 20.5-21 | | 20-20.5 | 4x70 | | 33.8-34.5 | 34 | 35 |
| 1x150 | | 22.5-23 | | 22-22.5 | 4x95 | | 38.9-39 | 38-38.5 | 39-39.5 |
| 1x185 | | 24.6-25 | | 25 | 4x120 | | 42-42.5 | 42 | 43-44 |
| 1x240 | | 27-28 | | 28 | 4x150 | | 47-47.5 | 46 | 46 |
| 1x300 | | 29.7-30 | | 30 | 4x185 | | 52 | 51 | 51 |
| 2x1.5 | 8.7 | 11-12 | | | 4x240 | | 58 | | 56 |
| 2x2.5 | | 12-12 | | | 4x300 | | 62.4 | | 64-65.5 |
| 2x4 | | 14-15 | | | 4x25/16 | | | 27.6-28 | |
| 2x6 | | 15 | | | 4x35/16 | | | 28.6-29 | |
| 2x10 | | 16.5-17 | 11 | | 4x50/25 | | | 33 | |
| 2x16 | | 18.5-19 | 12 | | 4x70/35 | | | 37 | |
| 2x25 | | 23-23.5 | | | 4x95/50 | | | 43-43.9 | |
| 2x35 | | | | | 4x120/70 | | | 47 | |
| 3x1.5 | 8.2-9.1 | 11.2-12 | 13 | | 4x150/70 | | | 51 | |
| 3x2.5 | 9.4-10.4 | 12.2-13 | 13.5 | | 4x185/95 | | | 56 | |
| 3x4 | 10.8-12 | 14-15 | 15.5 | | 4x240/120 | | | 62.5-63 | |
| 3x6 | 12.2-13 | 15-16 | 17 | | 4x300/150 | | | | |
| 3x10 | 14.7 | 17-18 | 19-19.5 | | 5x1.5 | 9.5-10.3 | 13-14 | 14.5 | |
| 3x16 | | 19-20 | 20.5-21 | | 5x2.5 | 11-12 | 14.2-15 | 15.5 | |
| 3x25 | | 24 | 24-25 | | 5x4 | 13.2-14.5 | 16.3-17 | 17 | |
| 3x35 | | 22.6-25.4 | | | 5x6 | 14.5-16.1 | 18-19 | 18.5 | |
| 3x50 | | 26.5 | | | 5x10 | 17.7-19.2 | 19.5-21 | 20.5-21 | 19.3-22 |
| 3x70 | | 29.7-30 | | | 5x16 | 21.2-23.4 | 22.4-23 | 23-23.5 | 22.5-25 |
| 3x95 | | 33.8-34.5 | | | 5x25 | 25.7-28.7 | 27.5-29 | | 27.1-28 |
| 3x120 | | 35.8-37 | | | 5x35 | 33.5 | 33.6-35 | | 30.2-31 |
| 3x150 | | 39, 8-40 | | | 5x50 | | 40-41 | | 35-36.2 |
| 3x185 | | 46 | | | 5x70 | | 42-48 | | 40-44 |
| 3x240 | | 51 | | | 5x95 | | 50-50.3 | | 45-47 |
| 3x25/16 | | 24.5 | 25.5-26 | | 5x120 | | 51.3 | | 49-53 |
| 3x35/16 | | 28 | 27-27.5 | | 5x150 | | 58.5 | | 56-57.8 |
| 3x50/25 | | 28.7-29 | 28.7-29.5 | | 5x185 | | | | 59 |
| 3x70/35 | | 32 | 33 | | 5x240 | | | | 71 |
| 3x95/50 | | 37.8-38 | 38 | | 7x1.5 | 10.5-11.5 | 15.5-15 | | |
| 3x120/70 | | 41 | 41 | | 7x2.5 | 12.6-13.2 | 16.5-17 | | |
| 3x150/70 | | 45-46 | 45 | | 19x1.5 | | 22-22.5 | | |
| 3x185/95 | | 50-51 | 50 | | 19x2.5 | | 23-23.5 | | |
| 3x240/120 | | 57-58 | 57 | | 24x1.5 | | 25-25.5 | | |
| 3x300/150 | | 64 | | | 24x2.5 | | 27-27.5 | | |

Short designations of cables and lines

| | |
|----------|---|
| NYM | Sheathed cable |
| NYY/NAYY | Cable with plastic sheath |
| NYCY | Cable with concentric conductor and plastic sheath |
| NYCWY | Cable with concentric, wave-shaped conductor and plastic sheath |

AKM/ASS mounted cable glands

Degree of protection IP 66 / IP 67 / IP 69
with strain relief and locknut



| Cable external diameter | | Cable entry metric |
|-------------------------|-----------|-----------------------|
| min. mm Ø | max. mm Ø | |
| 4 | 6 | AKM 12 |
| 5 | 10 | AKM 16 |
| 6.5 | 13.5 | AKM 20 |
| 11 | 17 | AKM 25 |
| 15 | 21 | AKM 32 |
| 19 | 28 | AKM 40 |
| 27 | 35 | AKM 50 |
| 35 | 42 | AKM 63 |
| 2 | 5 | ASS 12 |
| 3 | 10 | ASS 16 |
| 5 | 13 | ASS 20 |
| 8 | 17 | ASS 25 |
| 12 | 21 | ASS 32 |
| 16 | 28.5 | ASS 40 |
| 21 | 35 | ASS 50 |
| 20 | 48 | ASS 63 |

ESM plug-in grommets

Degree of protection IP 55

Plug-in grommets are inserted into
the extended opening. No locknut is
required!

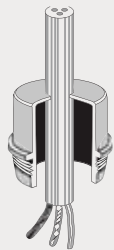

| Cable external diameter | | Cable entry metric |
|-------------------------|-----------|-----------------------|
| min. mm Ø | max. mm Ø | |
| 4.8 | 11 | ESM 16 |
| 6 | 13 | ESM 20 |
| 9 | 17 | ESM 25 |
| 9 | 23 | ESM 32 |
| 17 | 30 | ESM 40 |

STM stepped grommets

Degree of protection IP 55

Stepped grommets are inserted into
the extended opening. No locknut is
required!

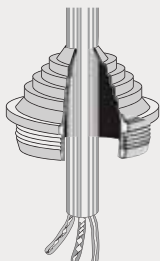

| Cable external diameter | | Cable entry metric |
|-------------------------|-----------|-----------------------|
| min. mm Ø | max. mm Ø | |
| 3.5 | 12 | STM 16 |
| 5 | 16 | STM 20 |
| 5 | 21 | STM 25 |
| 13 | 26.5 | STM 32 |
| 13 | 34 | STM 40 |

EDK plug-in grommets

Degree of protection IP 65

Plug-in grommets are inserted into the extended opening. No locknut is required!

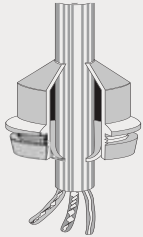

| Cable external diameter | | Cable entry metric |
|-------------------------|-----------|--------------------|
| min. mm Ø | max. mm Ø | |
| 5 | 10 | EDK 16 |
| 6 | 13 | EDK 20 |
| 9 | 17 | EDK 25 |
| 8 | 23 | EDK 32 |
| 11 | 30 | EDK 40 |

EDR grommets for conduits

Degree of protection IP 65

Plug-in grommets for conduits are inserted into the extended opening. No locknut is required!

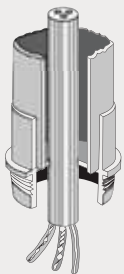

| Cable external diameter | | Cable entry metric |
|-------------------------|-----------|--------------------|
| min. mm Ø | max. mm Ø | |
| Conduit connection | | |
| M16 | | EDR 16 |
| M20 | | EDR 20 |
| M25 | | EDR 25 |
| M32 | | EDR 32 |
| M40 | | EDR 40 |

Hensel cable entries comply with the following standards and regulations:

- + IEC 62444
Cable glands for electrical installations
- + IEC 60423
Outside diameters of conduits for electrical installations and threads for conduits and fittings
- + IEC 60529
Degrees of protection provided by enclosures (IP Code)

Definition of terms

The IEC 61439-1 standard specifies rated values for the manufacture of low-voltage switchgear assemblies.

Rated voltage (U_n)

The highest rated mains voltage, AC voltage (RMS) or DC voltage specified by the manufacturer of the switchgear combination for which the mains circuits of the switchgear combination are designed.

Rated operating voltage (U_e) (of a switchgear combination circuit)

The voltage value specified by the manufacturer of the switchgear combination which, combined with the rated current, determines the use.

Rated insulation voltage (U_i)

Withstand voltage (RMS) specified by the manufacturer of the switchgear combination for a device or part thereof and indicating the defined (long-term) stability of its associated insulation.

Rated surge voltage (U_{imp})

The value of a surge voltage specified by the manufacturer of the switchgear combination which indicates the defined resistance of the insulation to transient overvoltages.

Rated current (I_n)

The value of the current specified by the manufacturer of the switchgear combination which can be carried under specified conditions without exceeding the specified excess temperatures of the various parts of the switchgear combination.

Unaffected short-circuit current (I_{cp})

RMS value of the current that flows when the supply line to the circuit is short-circuited by a conductor with negligible impedance in the immediate vicinity of the connections of the switchgear combinations.

Rated peak withstand current resistance (I_{pk})

The maximum instantaneous value of the short-circuit current specified by the manufacturer of the switchgear combination which is maintained under the specified conditions.

Rated short-time withstand current resistance (I_{cw})

The RMS value of the short-time current specified by the manufacturer of the switchgear combination, expressed as current and time, which can be withstood without damage under specified conditions.

Conditional rated short-circuit current (I_{cc})

The value of the unaffected short-circuit current that the circuit protected by a short-circuit protective device (SCPD) can withstand during the total switch-off time (current flow duration) of the device under specified conditions, as specified by the manufacturer of the switchgear combination.

Rated current of the power switchgear and controlgear assembly (I_{nA})

The rated current of the power switchgear and controlgear assembly is the smaller of:

- + the sum of the rated currents of the infeeds operated in parallel within the switchgear combination;
- + the total current that the main busbar can distribute in the respective configuration of the switchgear combination.

The current must be able to be carried without the heating of the individual parts exceeding the limits laid down in the standard.

Rated current of a circuit (I_{nc})

The rated current of a circuit is the value of the current that can be carried by that circuit under normal operating conditions when operated alone. This current must be able to be carried without the excess temperatures of the individual components of the switchgear combination exceeding the limits specified in the standard.

RDF (Rated Diversity Factor)

Percentage value of the rated current specified by the manufacturer of the switchgear combination with which the outlets of a switchgear combination can be subjected to constant stress, taking into account the mutual thermal influences.



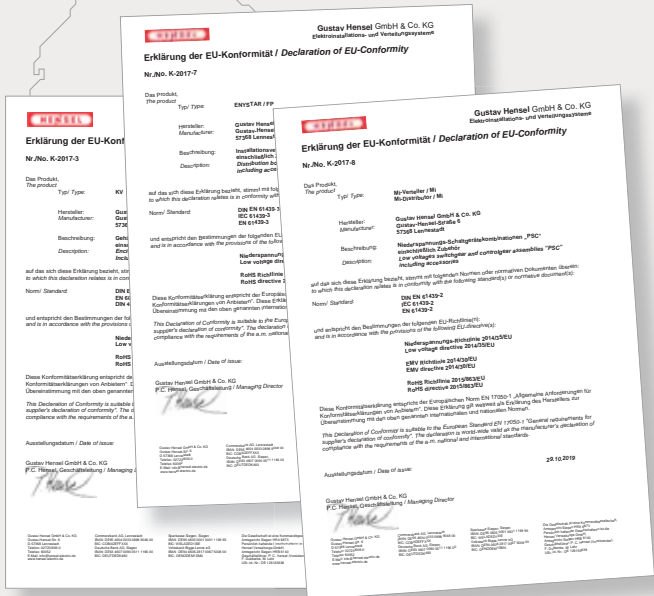

Gustav Hensel GmbH & Co. KG
 Elektroinstallations- und Verteilungssysteme

Erklärung der EU-Konformität / Declaration of EU-Conformity

Nr./No. K-2017-1

Das Produkt, The product: **Typ / Type:** DK ..., KF ..., KD ..., D ..., DE ..., RD ..., RK ..., K ..., DP ..., KC ..., DM ..., DN ..., KM ...

Hersteller, Manufacturer: **Gustav Hensel GmbH & Co. KG**
 Gustav-Hensel-Strasse 6
 D-57368 Lennebstadt

Beschreibung, Description: **Kabelabzweigkästen einschließlich Zubehör**
 Cable Junction Boxes including accessories

auf das sich diese Erklärung bezieht, stimmt mit folgenden Normen oder normativen Dokumenten überein: to which this declaration relates is in conformity with the following standard(s) or normative document(s):

Norm/ Standard: **DN EN 60670-22**
EN 60670-22
IEC 60670-22

und entspricht den Bestimmungen der folgenden EU-Richtlinie(n); and is in accordance with the provisions of the following EU-directive(s):

Niederspannungs-Richtlinie 2014/35/EU
 Low voltage directive 2014/35/EU

RoHS Richtlinie 2015/863/EU
 RoHS directive 2015/863/EU

Diese Konformitätserklärung entspricht der Europäischen Norm EN 17050-1 „Allgemeine Anforderungen für Konformitätserklärungen von Anbietern“. Diese Erklärung gilt weltweit als Erklärung des Herstellers zur Übereinstimmung mit den oben genannten internationalen und nationalen Normen.

This Declaration of Conformity is suitable to the European Standard EN 17050-1 "General requirements for supplier's declaration of conformity". The declaration is world-wide valid as the manufacturer's declaration of compliance with the requirements of the a.m. national and international standards.

Ausstellungsdatum / Date of issue: **29.10.2019**

Gustav Hensel GmbH & Co. KG
 P.C. Hensel, Geschäftsleitung / Managing Director

| | | | |
|---|--|---|---|
| Gustav Hensel GmbH & Co. KG Gustav-Hensel-Str. 6 D-57368 Lennebstadt Telefon: 0272360-0 Telefax: 02022 E-Mail: info@hensel-electric.de www.hensel-electric.de | Commerzbank AG, Lennebstadt IBAN: DE55 4004 0003 0008 9048 00 BIC: COMDE33HAN Deutsche Bank AG, Siegen IBAN: DE55 4007 0001 0011 1108 00 BIC: BFSWDE33HAN | Sparkasse Siegen, Siegen IBAN: DE55 4005 0001 0001 1809 90 BIC: SSKS2333 Volksbank Siegen-Lenne AG IBAN: DE55 4005 0001 0001 0008 00 BIC: GENODEM33HAN | Die Geschäftsleitung ist eine Kommanditgesellschaft, Gesellschaft Siegen (RA 6873) Personen: Volker Grottelmann ist die Person der Vertretung-Gesetzl. Angehöriger Siegen (RB 6140) Geschäftsführer: P. C. Hensel (Vorstand), Ulf-G. W. W. 126 10010000 |
|---|--|---|---|



The current EU declarations of conformity can be found on the Internet at:
www.hensel-electric.de/en-in/produkte/

CUSTOMISED SOLUTIONS

HENSEL implements up-to-date standards



Ready-to-connect distribution boards up to 2500 kW/2800 kVA in accordance with the application guides VDE-AR-N 4105:2018-11 and VDE-AR-N 4110:2018-11 and the requirements of the grid operators



UP TO 2800 kVA





ENYEXPERT – MORE KNOWLEDGE IN YOUR HAND

Always be up-to-date on the go. In addition to useful information, the HENSEL app offers simple and practical tools to make your everyday work easier.

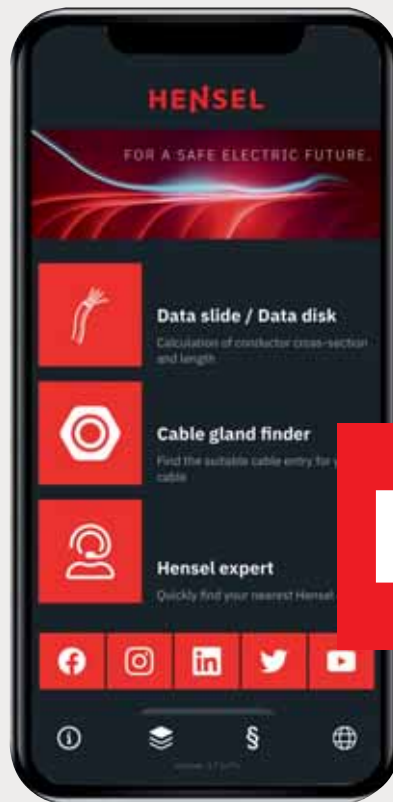
- + **Data slide / Data disc**
Calculation of conductor cross section and length
- + **Cable gland finder**
Find the suitable cable entry for your cable
- + **HENSEL expert**
Quickly find your nearest HENSEL expert



 AVAILABLE FREE OF CHARGE
FOR ANDROID AND IOS

| | | | |
|---|---|---|---|
|  | ANDROID Scan the QR code directly now |  | iOS Scan the QR code directly now |
|---|---|---|---|

SERVICE@HENSEL – DIGITAL, ANALOGUE AND ON SITE

In addition to the ENYEXPERT app,
HENSEL offers other useful and innovative
tools that significantly facilitate the
everyday work in the electrical trade:



+ MY HENSEL-BOX

Your Logo on the HENSEL-box

Use the HENSEL-box as a business card for your installation services



Please contact
your HENSEL expert:
hensel.in

+ ENYGUIDE

The 3D Configurator for Mi- and ENYSTAR distribution boards

Whether as a 2D drawing or as a three-dimensional image – The intuitive 3D
planning tool ENYGUIDE supports electrical specialists in the planning, project
planning and ordering of HENSEL ENYSTAR and Mi Distribution boards.



More:
enyguide.de

+ CALCULATION TOOL

for the verification of the permissible temperature rise

The online tool for quickly and easily determining the power loss.



+ PORTAL 61439

The platform with all information about design and assembly
according to IEC 61439 / EN 61439.





FOR A SAFE
ELECTRIC FUTURE.

HENSEL



Hensel Electric India Pvt. Ltd.

35, Kunnam Village
Sunguvarchathram - Walajabad Road
Sriperumbudur- 631 604
Kanchipuram Dist, Tamil Nadu

Tel : + 91 44 6712 7700
Fax : + 91 44 6712 7724
info@hensel-electric.in
hensel.in