

Modular enclosure system

to built up power switchgear and controlgear assemblies (PSC) up to 630 A according to IEC 61439-2

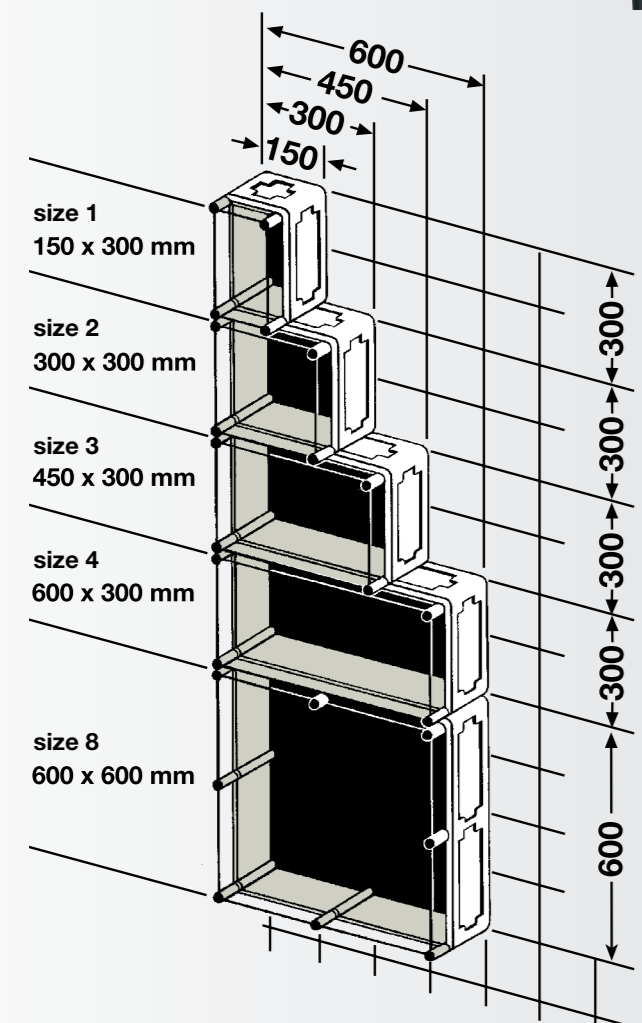
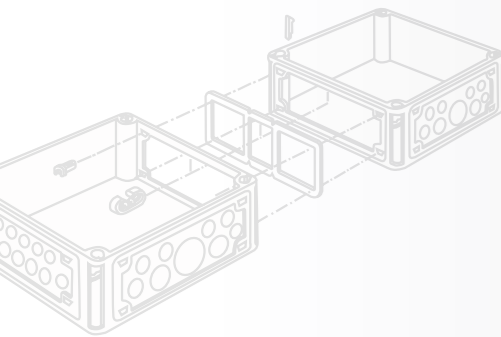

Combinable in all directions

- Five box sizes can be combined in all directions and can also be used as an individual box.
- The combinable system is ideally for the fast and simple assembly up to 630 A

High quality material

for demanding applications

- Flame-retardant, self-extinguishing burning behaviour: Glow wire test 960° C according to IEC 60 695-2-11
- UV resistant



- Robust and resistant: Mi distribution boards are resistant to dust and water and withstand the harshest conditions



- Safe even in the most extreme weather conditions outdoors, e.g., with a canopy.

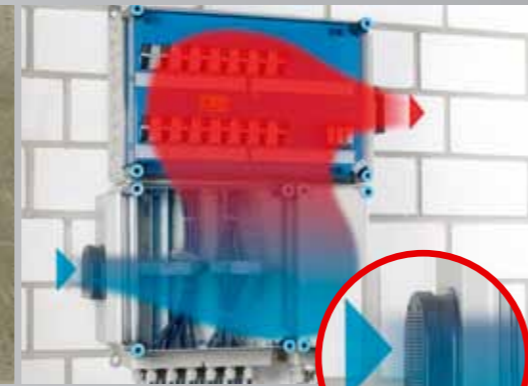

- Ventilation facilities to reduce the formation of condensation



- Cover strips cover the equipment openings from accidental contact.



- Protection covers for operating devices and bus-mounted devices for protection against contact



- Protection class II, □ (Total insulation)
- Appropriate accessories and enclosures with removable DIN rail rack and earth connection allow to build up distribution boards in protection class I (earthed).

Connection-ready solutions

for special applications



- Main line distribution boards



- Changeover switch boxes (I-0-II) reliably switch to backup power sources
- Inverter collector
- Connection of generation facilities



Easy and flexible

during assembly, connection and installation



- Removable box fin to insert cables via two boxes or a simpler wiring



- The cable insert allows inserting cables from the front.



- External brackets or mounting profiles for wall fastening

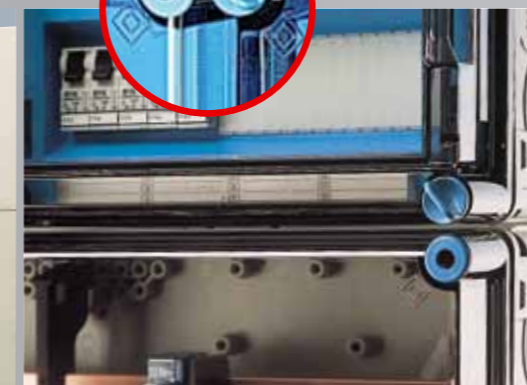

- Depending on the electrical function operate the cover manually (for unskilled persons) or with tools (for skilled persons)



- Lid lock prevents unauthorised opening of cover



- A hinged lid for simple operation of equipment.



- Individual box with electrical functions ...



- ... can be built individually by the electrician for a distribution board.

Always the suitable locking system

for access and operation areas

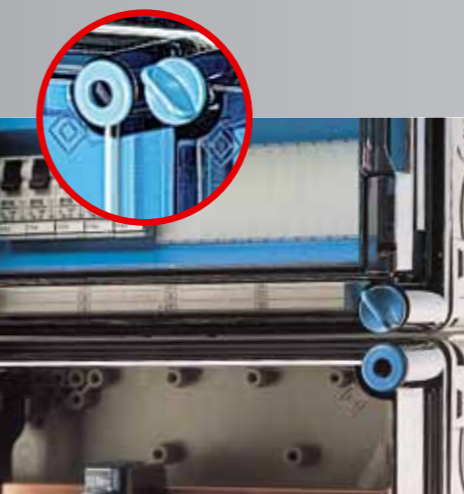

- Depending on the electrical function operate the cover manually (for unskilled persons) or with tools (for skilled persons)



- Lid lock prevents unauthorised opening of cover



- A hinged lid for simple operation of equipment.

Combinable solutions

for the self-assembly of distribution boards up to 630 A

Configurator ENYGUIDE

supports design and project engineering of Mi distribution boards

The intuitively usable 3D planning tool supports electricians, electrical engineers and wholesalers during design, project engineering and ordering of Mi distribution boards.

- Data export of the installation layout in a dxf-format, the parts list in either a ASCII or Excel format.
- Testing of the mechanical assembly incl. automatically necessary supplements, e.g., box walls, busbar connectors etc.
- Different layers with the projection of assemblies, covers and doors, e.g., behind protection covers

ENYGUIDE

Online via the Internet at www.enyguide.eu or offline on CD-ROM.

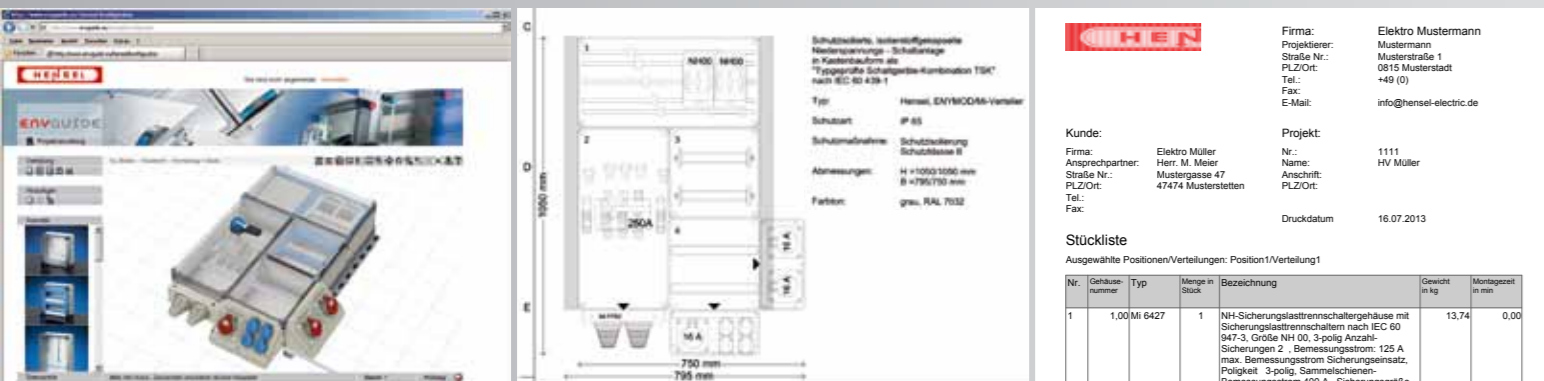

- Comfortable project engineering with the configurator in 3D.
- Generation of the layout for electricians.
- Automatic creation of the parts and order list.

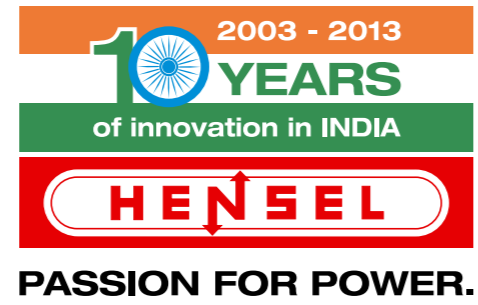

Hensel Electric India Pvt Ltd

Industrial Electrical Power Distribution Systems

35 Kunnam Village, Sunguvachathram
Walajabad Road
Sriperumbudur - 631 604
Kanchipuram Dist., Tamil Nadu
INDIA

Phone: +91-44-3727 0202
Fax: +91-44-3727 0200
E-Mail: info@hensel-electric.in
www.hensel.in

Representations abroad

- | | | | | | |
|--|------------------------------------|---|--|--|--|
| Africa
Angola
Egypt
Mozambique
South Africa | America
Argentina
USA | Asia
Bangladesh
Bhutan
Cambodia
Georgia
India
Indonesia
Kazakhstan
Malaysia
Maldives
Myanmar
Pakistan
People's Republic of China
Philippines
Singapore
South Korea
Sri Lanka
Taiwan
Thailand | Finland
France
Great Britain
Greece
Hungary
Iceland
Ireland
Israel
Italy
Latvia
Lithuania
Luxembourg
Montenegro
Netherlands
Norway
Poland
Portugal
Romania
Russia
Serbia and
Slovakia
Spain
Sweden
Switzerland
Turkey
Ukraine | Middle East
United Arab Emirates
Bahrain
Iran
Kuwait
Oman
Qatar
Saudi Arabia | Oceania
Australia
New Zealand |
|--|------------------------------------|---|--|--|--|



Hensel Electric India Pvt Ltd

Industrial Electrical Power Distribution Systems

35 Kunnam Village, Sunguvachathram
Walajabad Road
Sriperumbudur - 631 604
Kanchipuram Dist., Tamil Nadu
INDIA

Phone: +91-44-3727 0202
Fax: +91-44-3727 0200
E-Mail: info@hensel-electric.in
www.hensel.in

Safe, Even in Extreme Environments!

Mi Power Distribution Boards up to 630 A



Combinable system

for the assembly of power switchgear and controlgear assemblies (PSC) up to 630 A



- According to IEC 61 439-2
- Power distribution board up to 630 A as power switchgear and controlgear assembly (PSC)
- Degree of protection IP 65
- Protection class II, □
- EMC compliant busbar system
- Certified by ASTA
- Suitable for indoor installation and outdoor installation, protected against weather influences
- Pre-assembled enclosures with standardised kits up to 630 A
- Proven in commercial buildings in rough industrial atmospheres and difficult environments.



- Safe even in extreme environments such as dust, dirt, humidity and in harsh industrial environments.
- For protected installation outdoors, here e.g., with canopy



ENYMOD